



SOLHARO®

For glass Conservatories, Sun Rooms, and wood trellis Pergolas

The Solharo® is the ideal solar protection solution for sunrooms and conservatories and wood Trellis Pergolas. With a standard motor, the shade will automatically extend to shade and lower the temperature in the room. The system is designed for solar control and can only be used in rain if configured with mesh fabric only so water goes through it and does not collect.

Type	Standard Frame Colors	Standard Widths	Standard Projections	Recommended Applications	Recommended Fabrics
Tensioned Track System Conservatory Shade	9 standard Sunair colors	Through 27' Split multiple bays See price list	5' through 19' 8" See Price list	Conservatory rooms and wood structures Retractable	Soltis 86 & 92 Mesh Sunbrella / Para

- Protects against the sun and lowers the temperature in the sun room, significantly lowering cooling costs.
- Used for sun protection and solar control only (Not for rain protection unless mounted on a 45 degree slope).
- The fabric blocks the sun before it hits the glass for more effective solar control.
- Prevents fading of your furniture, carpets, curtains, and wallpaper.
- Can cover small to large sun rooms & wood structures.
- Great for residential and commercial applications.
- Easy motorized operation standard.
- Hundreds of fabric or mesh colors to choose from.



Revised 02/15/2023

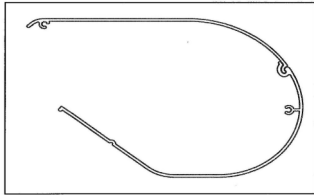

Please consult the office if a bay is less than 6'7" wide as a smaller spring is needed .

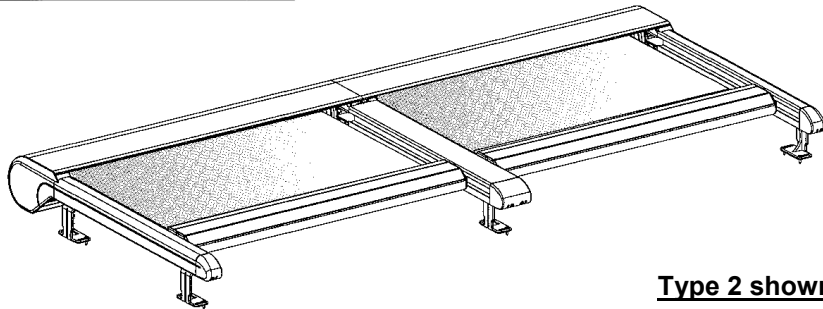

Type 2 shown

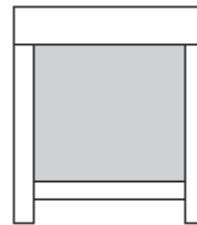

Type 1

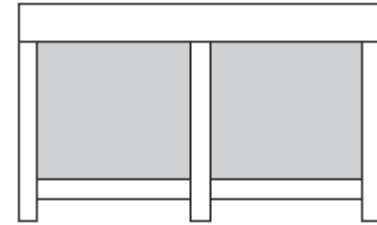

Type 2

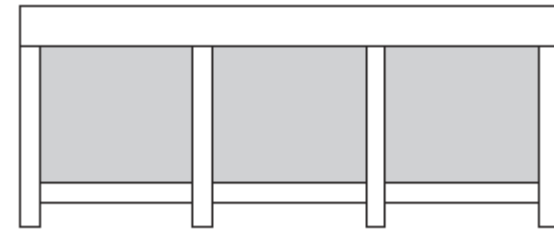

Type 3



Shown with extension brackets

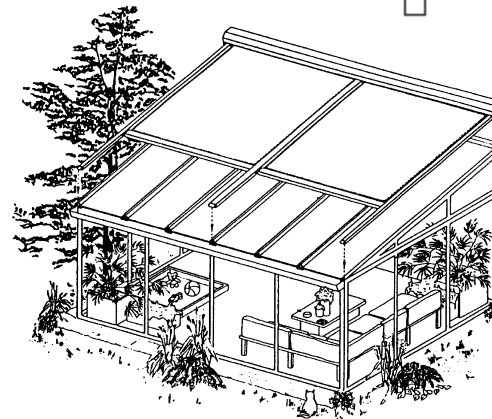

MEASURING SOLHARO

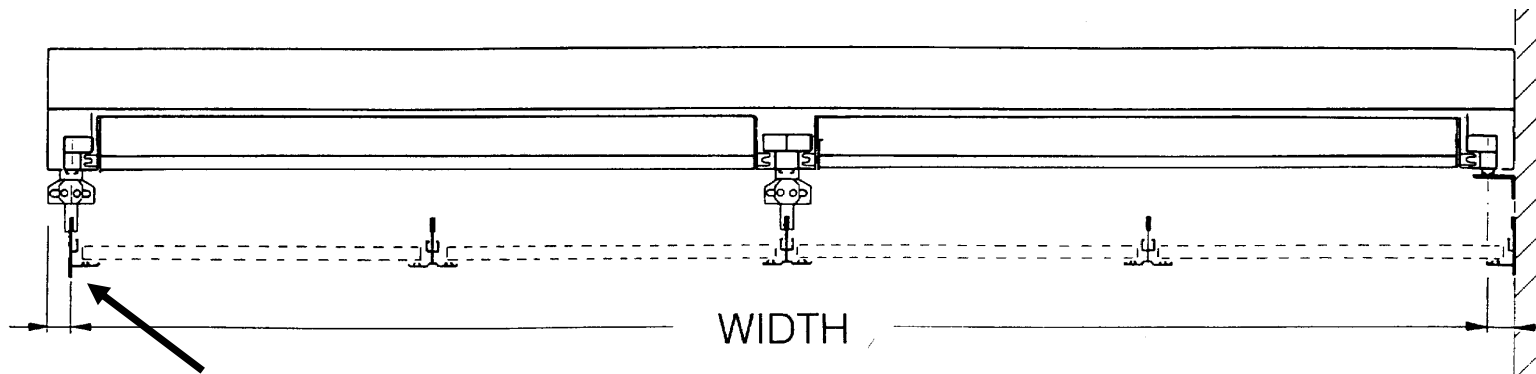

The cassette or end Tracks extends 1" beyond the center measurement of each track

The most important measurement is the measurement center to center of each beam of the structure. All orders must be submitted with the Solharo work sheet showing dimensions. The Solharo will then be manufactured with the guides or tracks running center of the beams. From the center of the outside lateral guides, the system extends 1" on each side (see illustration above). If multiple bays are required indicate where the center of each track needs to be. The bays can vary in size and it is not necessary to have each bay the same size. Consult the office if a bay is less than 6'7". The system can not extend down and around the curve. For best coverage you can extend the track 12" straight beyond the curve of the sunroom.

Note: Dimensions in metric mm

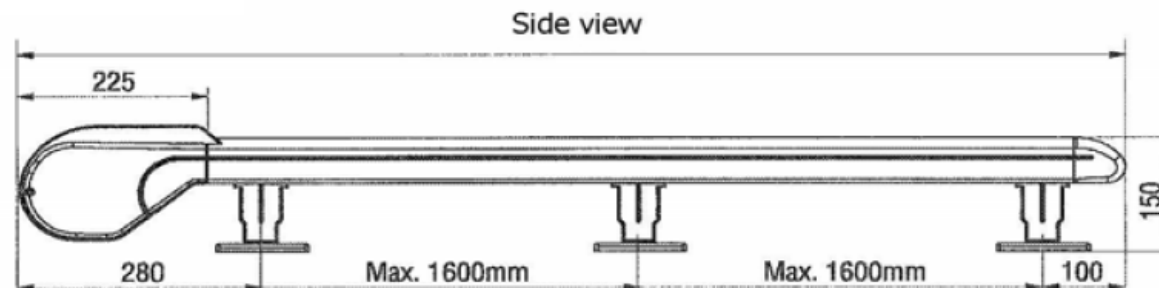

The aluminum housing containing the roller system is 6 ½" inches high or 165 mm high with the brackets. Different mounting situations can be accommodated (See further technical documents).

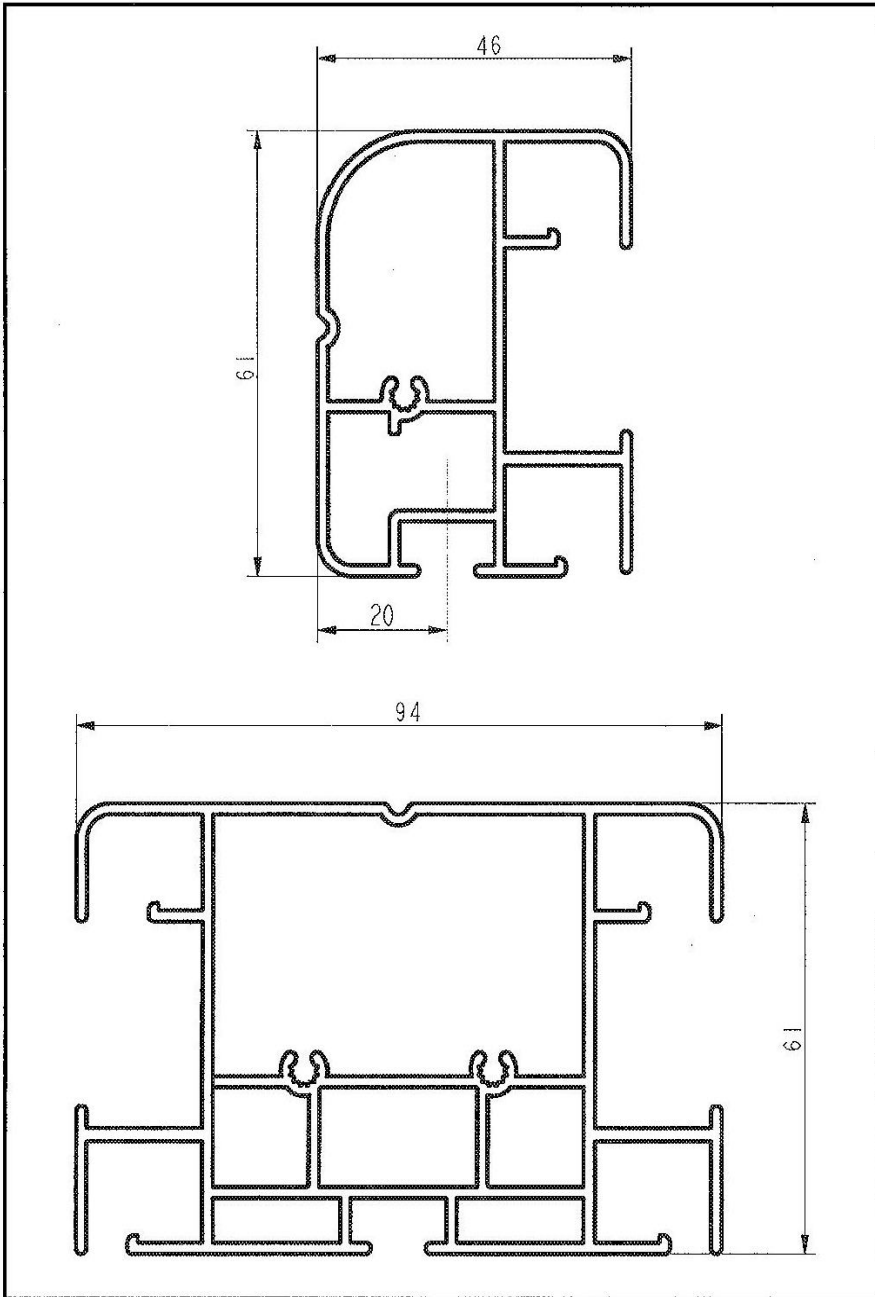

Note: Dimensions in metric mm

**Standard
brackets 3"**

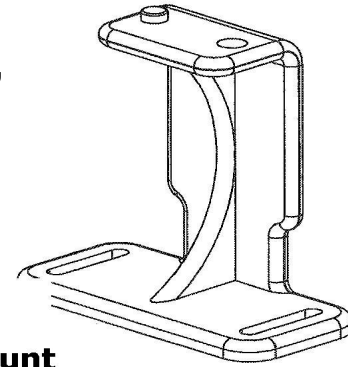

Standard Mount

**OPTIONAL
Extension
brackets 5"**

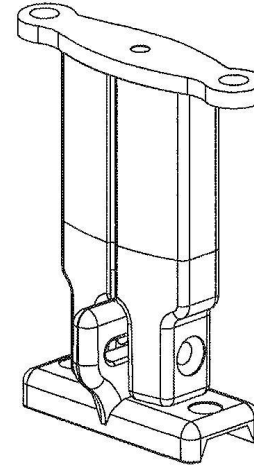

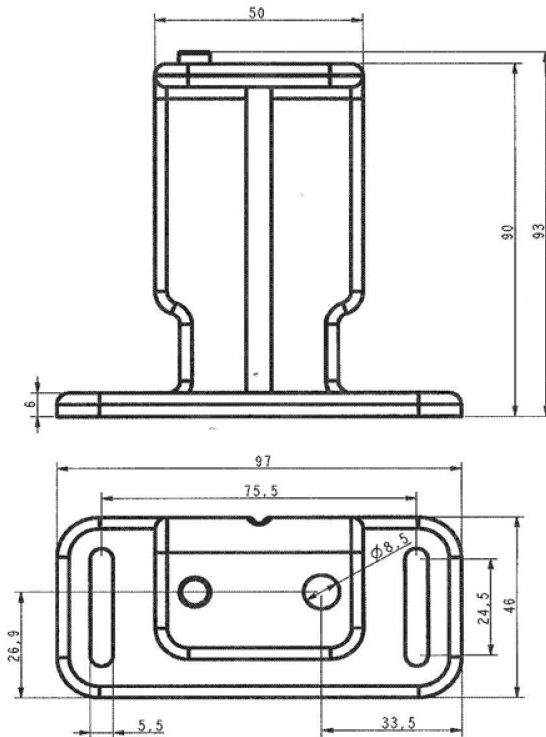
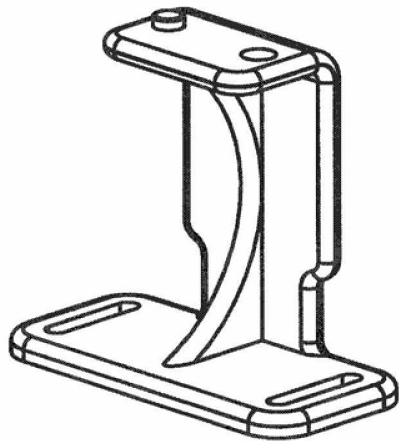
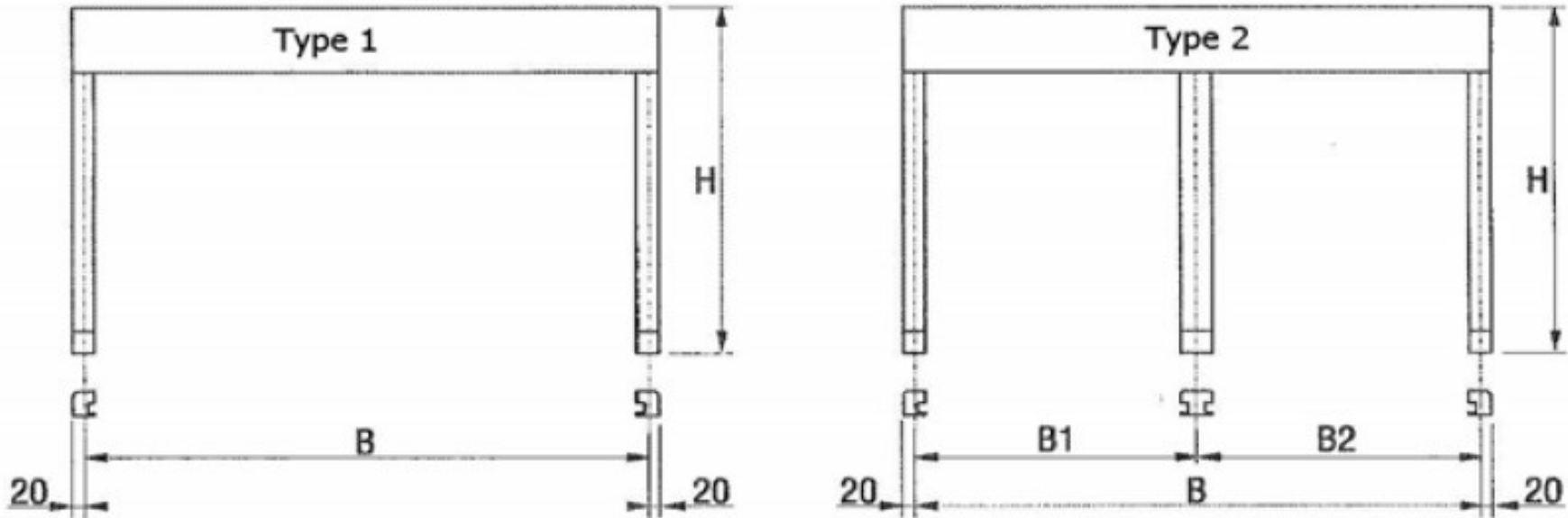

Note: Dimensions in metric mm

TECHNICAL DATA

- Minimum width per section: 2,00m (6'7")
- Maximum width per section: 4,50m (14'9")
- Maximum projection: 6,00m (19'8")
- Maximum area per fabric: ca20m²

Note:

Wider Type 1 sections are available than maximum indicated above. Please inquire with office. Unit will be out of spec with support roller needed to be added at extra cost. Max Type 1 width is 15 ft wide or 457 cm. depending on projection needed.

SOLHARO® EXPLODED VIEW

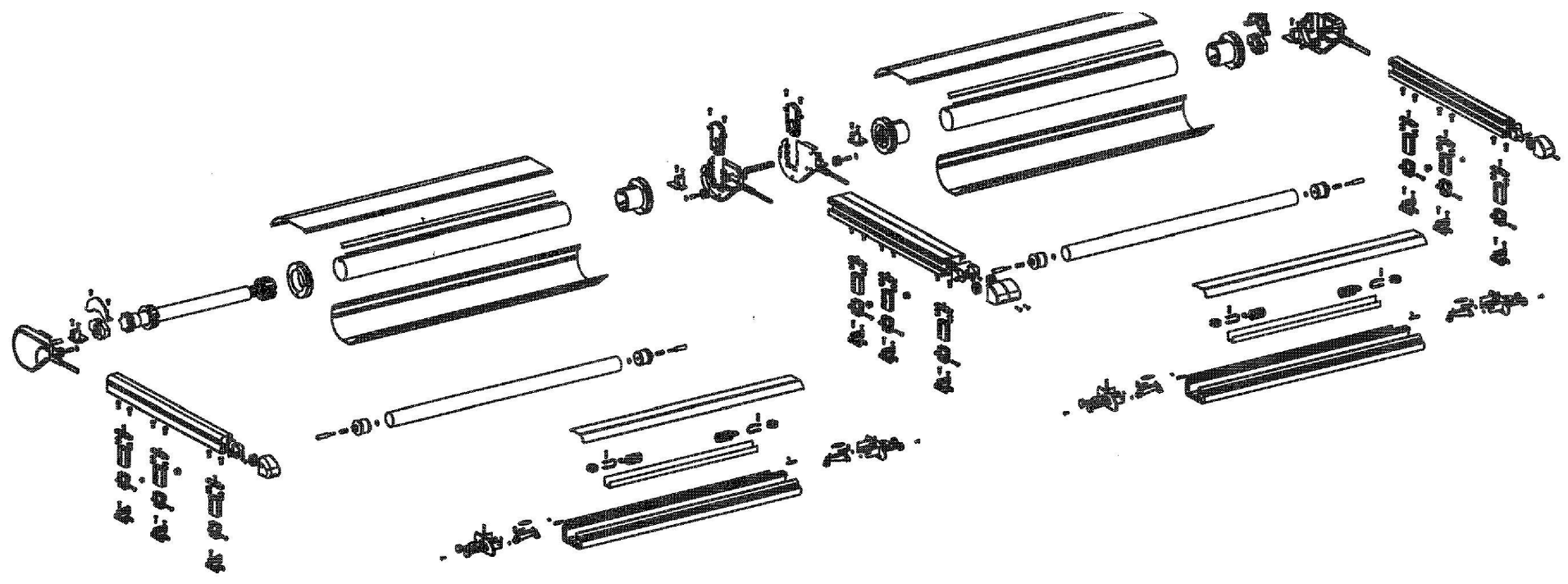

FRAME COLORS (STANDARD)

*Solharo**

*Note: See each model technical page for available frame colors. Available interior screen colors are different than depicted below (see Interior screens).

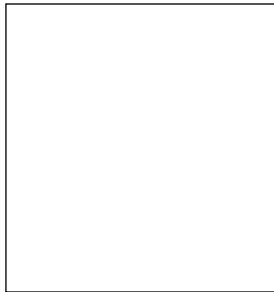

WHITE Gloss
Ral 9010

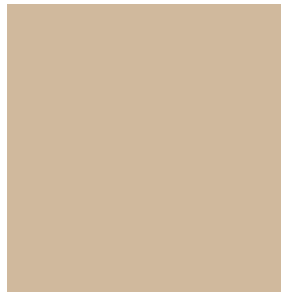

MOCHA
Semi Gloss

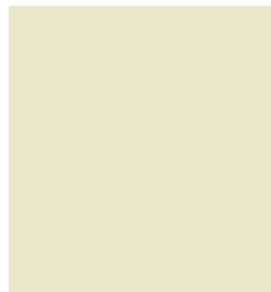

**DESERT SAND /
IVORY Gloss**



BLACK Gloss
Ral 9005



BRONZE
Coarse



GREY Gloss
Ral 7040

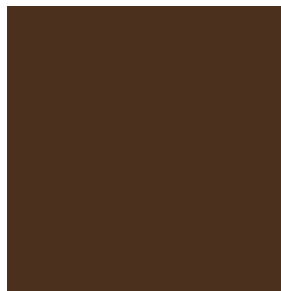

BROWN Gloss

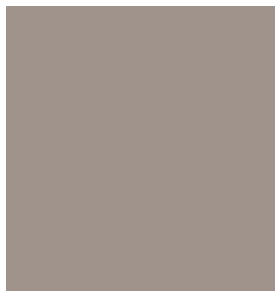

TAUPE Gloss



GREEN Gloss
Ral 6005

OPTIONAL

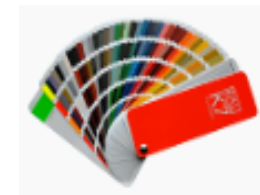

**FULL RAL COLOR
RANGE / EXTRA COST**

NOTE: All these colors except Green Ral 6005 and Desert Sand / Ivory are “super durables” which offer better durability compared with standard polyesters powders.

NOTE: ACTUAL FRAME COLOR MAY VARY FROM DIGITAL IMAGES





TEMPOTEST
ITALIAN PERFORMANCE FABRICS



ACRYLIC FABRIC COLLECTION



Fabric covers sewn with Tenara thread.



5 Forest Green



7 Moss Green



8 Medium Green



11 Red



12 Yellow



13 Ocean Blue

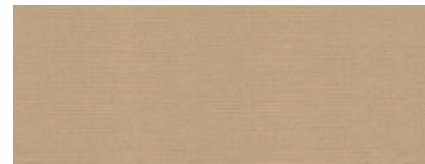

14 Toast

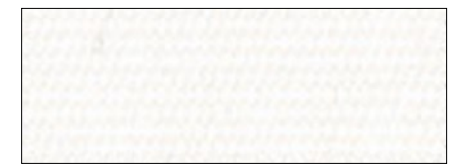

15 White

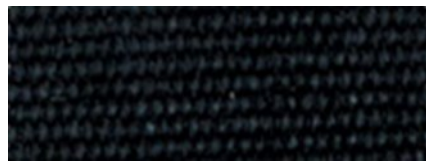

24 Black



33 Forest Green / White



35 Red / White



37 Yellow / White



47 Brown / Stone



52 Tan



53 Pale Peach



73 Burgundy



75 Navy Blue



79 Grey



81 True Brown



84 Dark Terracotta

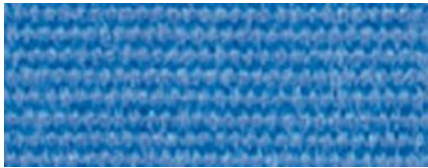

87 Fancy Blue



101 Elite Toast



102 Cappuccino



106 Toffee

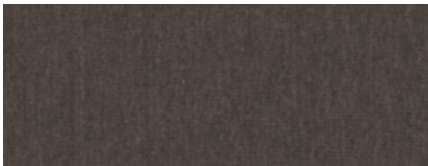

107 Textured Dk. Grey



242 Grey / White

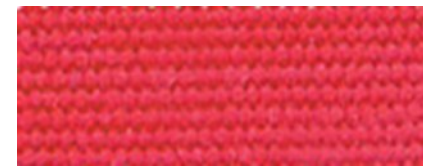

426 Terracotta



439 Dark Grey / White



809 Cream / Green



878 Beige / White Speckled



926 Taupe Classic Solid

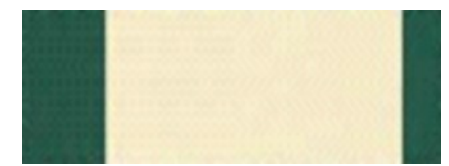

931 Green / Cream Wide



969 Grey Fancy Stripe

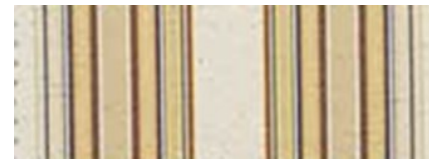

1101 Beige / Stripe Fancy



1120 Brown/ Beige Fancy



1150 Rust / Green Multi



116/15 Medium Blue / White



1243 Yellow Multi



1302 Sage Tweed



1330/512 Carbon Stitch



15/1 Beige



15/14 Raw



15/79 Stone



4015/91 Raw Speckled



407/11 Burgundy Tweed



407/13 Blue Tweed



407/14 Toast Classic Tweed



407/16 Moss Classic Tweed



407/3 Green Classic Tweed

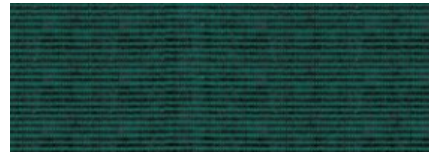

407/6 Green Tweed



407/79 Pepper Grey



407/926 Grey Classic Tweed



4215/15 Textured Tan



5000/57 Cocoa Stripe



5001/1 Green Graduated



5001/13 Blue Graduated



5001/7 Moss Graduated



5001/73 Burg/Grey Graduated



5009/1 Beige / Tan Stripe



5009/14 Brown / Tan Stripe



5011/11 Brick/Natural Fancy

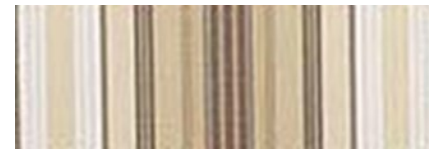

5011/57 Tan / Brown Fancy



5011/7 Tan / Green Fancy



5071/7 Natural/Moss Graduated



5072/86 Brown/Stone Fancy



5118/62 Yellow / White Fancy



5144/14 Pastel/Natural Fancy



5167/11 Red / Grey Fancy



5167/2 Blue / Grey Fancy



5167/5 Green / Grey Fancy



5173/12 Yellow / Grey Stripe



5304/15 Rose / Grey Fancy



5347/58 Grey Wheat Multi



5347/79 Platinum Grey Multi



5348/58 Beige / Wheat Multi



5348/79 Grey / Slate Multi



5349/106 Brown Cream Stripe

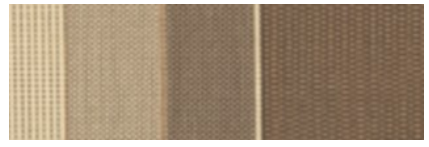

5349/930 Beige / Brown Classic

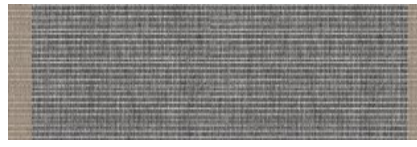

5369 Charcoal / Brown



5370 Beige / Grey



5371/727 Grey / Black Stripe



5374 Smoke / Grey Stripe

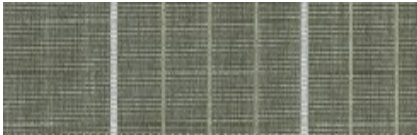

5396/78 Green Tweed Stripe

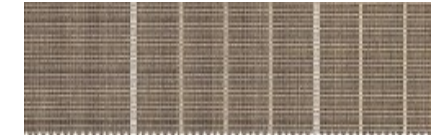

5396/930 Hazelnut Stripe



5396/97 Charcoal Tweed Stripe



5397/97 Grey / Black Graduated

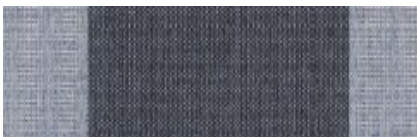

5398/107 Carbon Blue Blend

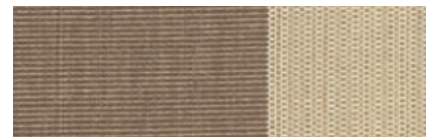

5398/930 Dune / Brown Striped

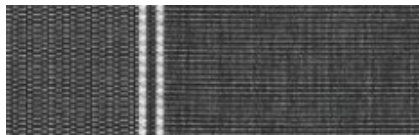

5399/107 Drk. Grey Tweed

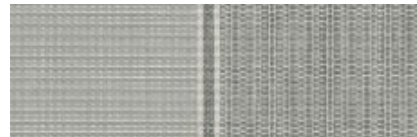

5399/15 Lgt. Grey Stripe



5399/52 Sesame Tweed
Stripe



5399/94 Stone / Grey
Tweed



5406/52 Coriander Tweed



5406/94 Textured / Desert
Beige

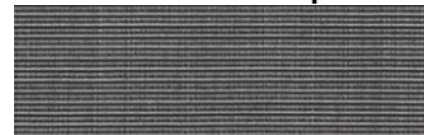

5407/107 Charcoal /
Stone Tweed



5407/15 Textured Silk
Grey

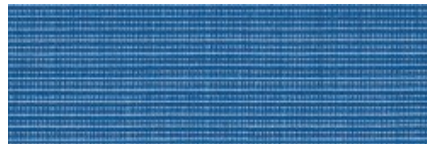

5407/17 Sky Tweed



5407/52 Sesame Tweed



5407/94 Desert Grey
Tweed



633/79 Grey/ Black Fancy



634/51 Grey / Natural Fancy



634/97 Green / Tan Fancy



635/11 Cranberry/Natural F.



636/10 Grey / Blue Graduated



636/12 Yellow Graduated



636/14 Brown Elite Stripe



636/5 Green / Beige Fancy



636/84 Terracotta Graduated



638/5 Green Grey Fancy



639/99 Tan / Natural Fancy



641/10 Blue / Beige Fancy

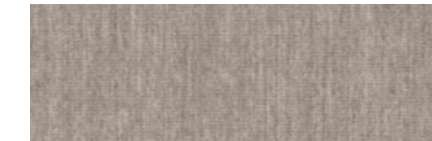

727/15 Textured Med. Grey



739/701 Sage / Beige Fancy



769/75 Cream / Blue Fancy



**782/14 Beige Classic
Solid**

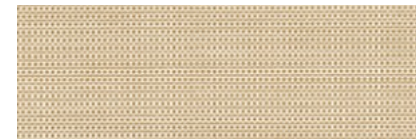

873/151 Dune Tweed

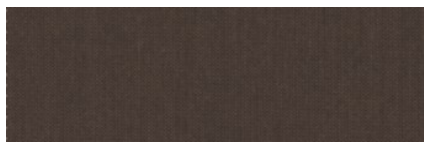

873/2 Textured Cocoa



939/94 Grey Elite Stripe



940/5 Green Elite Stripe



947/14 Pale / Beige Classic

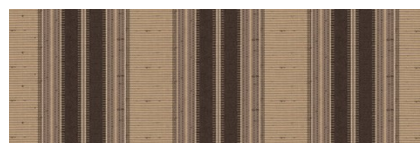

**949/91 Brown Beige
Classic**

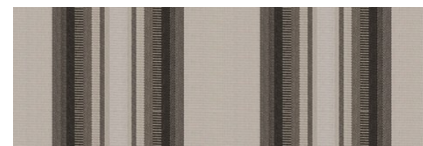

**950/24 Grey / Charcoal
Classic**

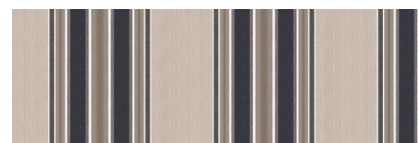

**951/92 Grey / Navy
Classic**



967/926 Grey/Charcoal Elite



**968/426 Terracotta Cream
Fancy**



97/84 Plum

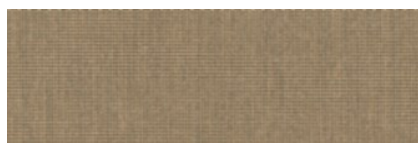

986/106 Textured Beige



986/15 Textured Lt. Grey



**986/727 Textured Pebble
Grey**

SOLIDS · TWEEDS · BLOCK STRIPES · FANCY STRIPES · GRADUATED STRIPES

5	Forest Green	407/14	Toast Classic Tweed	5406/52	Coriander Tweed
7	Moss Green	407/16	Moss Classic Tweed	5406/94	Textured Desert Beige
8	Medium Green	407/3	Green Classic Tweed	5407/107	Charcoal/Stone Tweed
11	Red	407/6	Green Tweed	5407/15	Textured Silk Grey
12	Yellow	407/79	Pepper Grey	5407/17	Sky Tweed
13	Ocean Blue	407/926	Grey Classic Tweed	5407/52	Sesame Tweed
14	Toast	4215/15	Textured Tan	5407/94	Desert Grey Tweed
15	White	5000/57	Cocoa Stripe	633/79	Grey/Black Fancy
24	Black	5001/1	Green Graduated	634/51	Grey/Natural Fancy
33	Forest Green/White	5001/13	Blue Graduated	634/97	Green/Tan Fancy
35	Red/White	5001/7	Moss Graduated	635/11	Cranberry/Natural Fancy
37	Yellow/White	5001/73	Burgundy/Grey Graduated	636/10	Grey/Blue Graduated
47	Brown/Stone	5009/1	Beige/Tan Stripe	636/12	Yellow Graduated
52	Tan	5009/14	Brown/Tan Stripe	636/14	Brown Elite Stripe
53	Pale Peach	5011/11	Brick/Natural Fancy	636/5	Green/Beige Fancy
73	Burgundy	5011/57	Tan/Brown Fancy	636/84	Terracotta Graduated
75	Navy Blue	5011/7	Tan/Green Fancy	638/5	Green/Grey Fancy
79	Grey	5071/7	Natural/Moss Graduated	639/99	Tan/Natural Fancy
81	True Brown	5072/86	Brown/Stone Fancy	641/10	Blue/Beige Fancy
84	Dark Terracotta	5118/62	Yellow/White Fancy	727/15	Textured Medium Grey
87	Fancy Blue	5144/14	Pastel/Natural Fancy	739/701	Sage/Beige Fancy
101	Elite Toast	5167/11	Red/Grey Fancy	769/75	Cream/Blue Fancy
102	Cappuccino	5167/2	Blue/Grey Fancy	782/14	Beige Solid Classic
106	Toffee	5167/5	Green/Grey Fancy	873/151	Dune Tweed
107	Textured Dark Grey	5173/12	Yellow/Grey Stripe	873/2	Textured Cocoa
242	Grey/White	5304/15	Rose/Grey Stripe	939/94	Grey Elite Stripe
426	Terracotta	5347/58	Grey/Wheat Multi	940/5	Green Elite Stripe
439	Dark Grey/White	5347/79	Platinum Grey Multi	947/14	Pale Beige Classic
809	Cream/Green	5348/58	Beige/Wheat Multi	949/91	Brown/Beige Classic
878	Beige/White Speckled	5348/79	Grey/Slate Multi	950/24	Grey/Charcoal Classic
926	Taupe Classic Solid	5349/106	Brown/Cream Stripe	951/92	Grey/Navy Classic
931	Green/Cream Wide	5349/930	Beige/Brown Classic	967/926	Grey/Charcoal Elite
969	Grey Fancy Stripe	5369	Charcoal/Brown	968/426	Terracotta/Cream Fancy
1101	Beige/Stripe Fancy	5370	Beige/Grey	97/84	Plum
1120	Brown/Beige Fancy	5371/727	Grey/Black Stripe	986/106	Textured Beige
1150	Rust/Green Multi	5374	Smoke/Grey Stripe	986/15	Textured Light Grey
116/15	Medium Blue/White	5396/78	Green Tweed Stripe	986/727	Textured Pebble Grey
1243	Yellow Multi	5396/930	Hazelnut Stripe		
1302	Sage Tweed	5396/97	Charcoal Tweed Stripe		
1330/512	Carbon Stitch	5397/97	Grey/Black Graduated		
15/1	Beige	5398/107	Carbon Blue Blend		
15/14	Raw	5398/930	Dune/Brown Stripe		
15/79	Stone	5399/107	Dark Grey Tweed		
4015/91	Raw Speckled	5399/15	Light Grey Stripe		
407/11	Burgundy Tweed	5399/52	Sesame Tweed Stripe		
407/13	Blue Tweed	5399/94	Stone/Grey Tweed		



Soltis
Horizon 86

Serge Ferrari

14 % Open Screen Mesh

Exterior Screen Fabric

5 year warranty from Ferrari

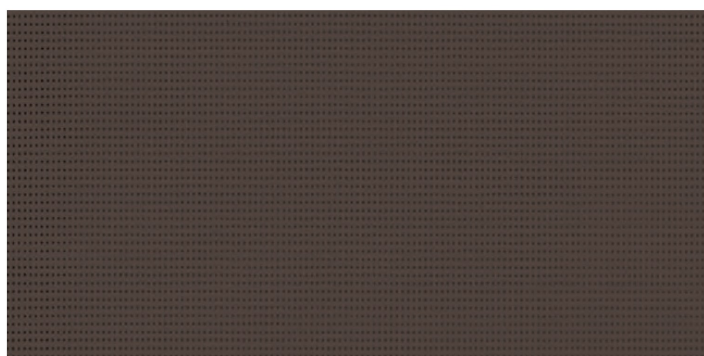

86-2043
Bronze

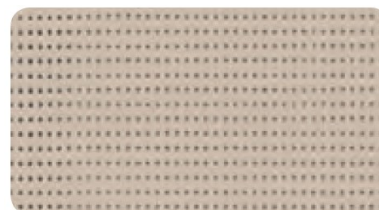

86 – 2135
Sandy Beige

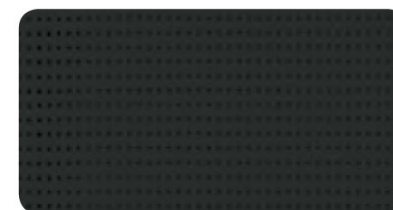

86 – 2053
Black



86 – 2175
Champagne

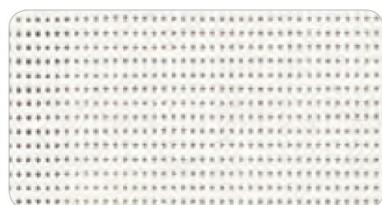

86 – 2044
White



86 – 2012
Pepper



86 – 2171
Boulder

■ **Technical properties**

Openess factor	14%
Weight	380 g/m ² — 11.2 oz/sqyd
Thickness	0.45 mm — 450 microns
Width	177 cm - 267 cm — 69.7 in. - 105.1 in.

Superior elongation and tear resistance

No deformation during processing and use

Superior aesthetic and mechanical durability

Smooth finish easy to clean, space saving, easy rolling

Exterior Screen Fabric



5 % Open Screen Mesh

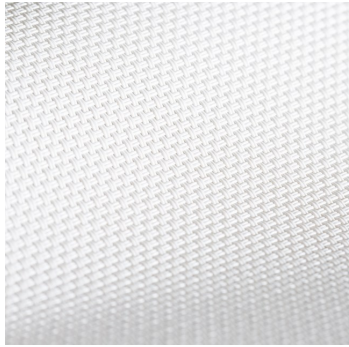

White

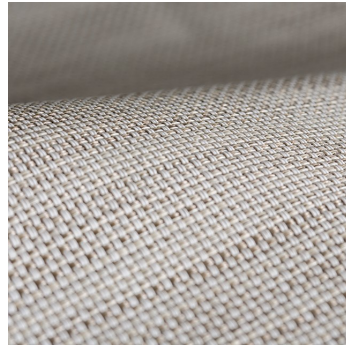

Stone Texture

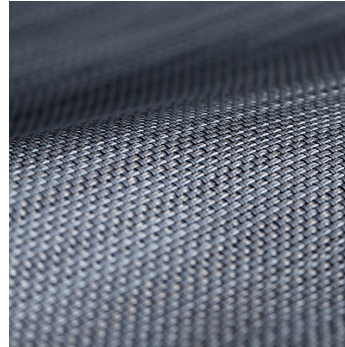

ShadowTexture

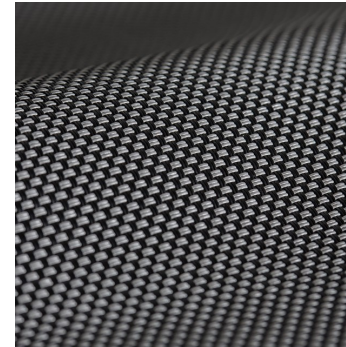

Granite

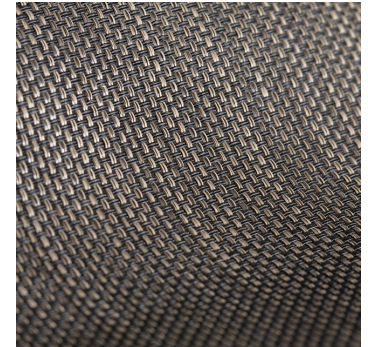

Espresso Texture

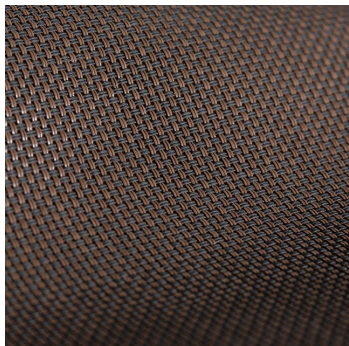

Tobacco

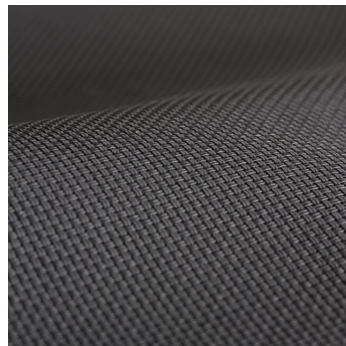

Charcoal

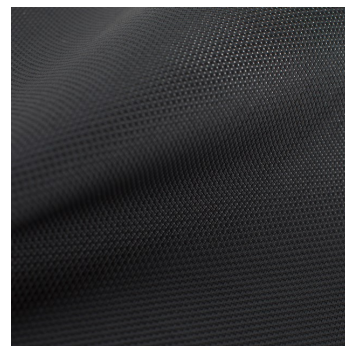

Flat Black



Bone

TEXTILENE® nano™ 95 is a durable, yet lightweight synthetic fabric. It is lighter and finer with the same technical qualities as the original TEXTILENE®. TEXTILENE® nano™95 is excellent for exterior use and can reduce energy costs while blocking up to 95% of the sun's harmful rays.





E Screen

Conventional | 1% 3% 5% 10% openness

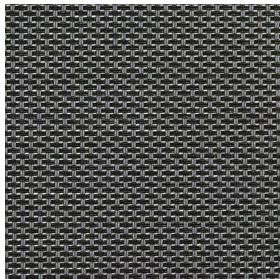

Charcoal / Grey



Charcoal / Charcoal

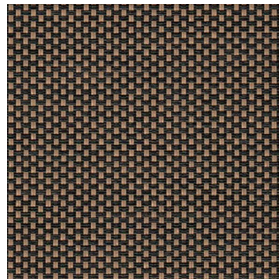

Charcoal / Apricot

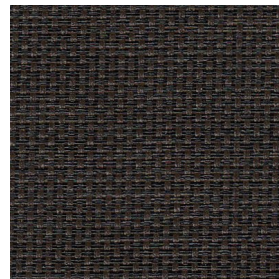

Charcoal / Cocoa



White / Linen

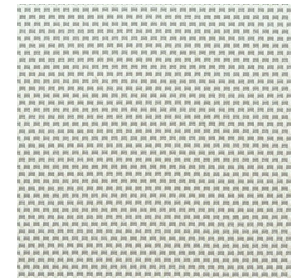

White / Pearl

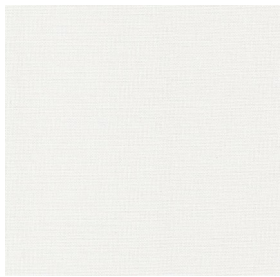

White / White

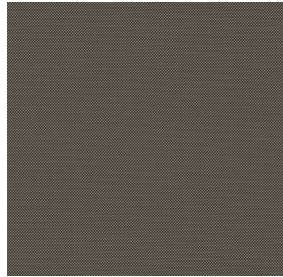

Charcoal Grey
/ Stone

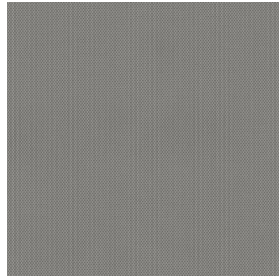

Pearl / Linen

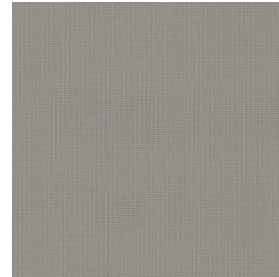

Pearl / Pearl

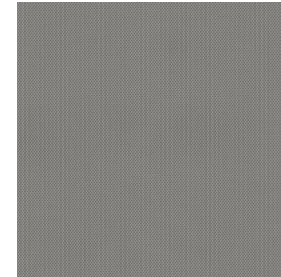

Pearl / Grey

Product Specifications Sheet



MOTORIZATION

POWERED by
somfy



Awnings



Exterior Screens



Pergolas



Roller/Solar Shades

Sunair is proud to offer the full line of Somfy motors and controls for our awnings and screens program. SOMFY RTS features motors with an integrated radio receiver that allows you to operate the awning by remote control with a wall mounted or hand held remote or by smart phone device. With a simple click of your remote, the awning or shade will extend or retract automatically. The manual override Sunea motor is ideal for awnings and the Altus motors is ideal for exterior screens. Each motor can be configured with a cord & plug which can simply be plugged into your patio outlet. They are available in 1.4", 11', 17', & 23' lengths. Altus motor cords depend on motor model and is standard either 6' or 10' pigtail cords. Optional Altus plug in cords are available in 10', 18', and 24' lengths. Optional screen motor is Maestria with obstacle detection. Add Tahoma smart phone and table interface.



ALTUS®

SOMFY REMOTES:



Telis 1 & 4 RTS
Hand-held Remotes



Situ 1 & 4 hand
held remotes

One (1) through (16) channel hand held or wall mounted remotes are available. Remotes are available in different colors to suit your style, please inquire.



Telis hand-held remotes offer convenient and simple operation of every type of motorized application. Channels help organize the motorized products that are operated. Single channel remotes can operate one individual product or one group of motorized products. Multiple channel remotes can handle groups of motorized products.



Telis 1 Chronis
RTS Timer



DecoFlex WireFree™ RTS
Wall Switches



Telis 1 Patio for
exterior use



Smooove® 1 RTS
Surface Mount Wall Switch



Telis 16 RTS
Hand-held Remote

AVAILABLE AUTOMATIC SENSORS & CONTROLS



SOLIRIS RTS 24V KIT
Sun & Wind Sensor

The Soliris RTS Sun and Wind Sensor automatically controls your RTS motorized products based on current weather conditions.



ONDEIS® WIREFREE
Sun & Rain Sensor

The Rain Sensor is a solar-powered combined rain and sun sensor compatible with Radio Technology Somfy® motorized exterior products, including awnings and screens.



Sunis & ThermoSunis
Indoor WireFree™ RTS Sensors



SOMFY MOTOR WIRING



Radio Technology Somfy

Radio Technology Somfy® (RTS) allows wireless radio control of motorized applications via the RTS family of controls.



The three (3) wire cords can be wired in parallel and can be ordered with a molded plug to simply plug into an exterior UL approved GFI outlet. The standard four (4) wire cords must be hard wired with a traditional toggle wall switch. Screens can not be ordered with molded plugs on the end.

Optional molded plug is available for "awning" motors only



Type of power cable **RTS plug in capable motor cord**

RTS
120V AC / 60Hz
3 conductor cable

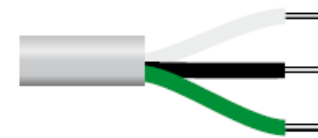

white = neutral
black = hot
green = ground

All Somfy Motors are UL and CSA Recognized

- All SOMFY motors are UL Recognized and can be found under the following file numbers:
E60495, E60888, E63714



Type of power cable **STANDARD Hardwire motor cord**

Wired
120V AC / 60Hz
4 conductor cable



white = neutral
red = direction 1
black = direction 2
green = ground

Hardwired motors with a wall switch

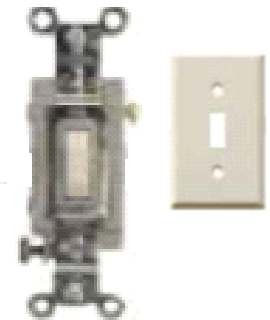
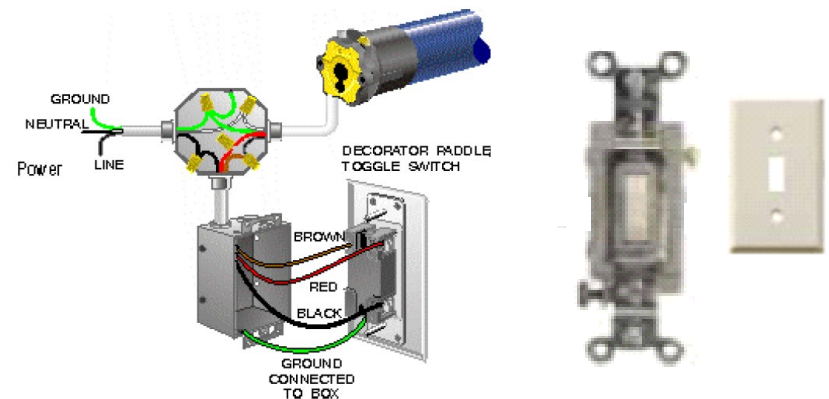

LT50 Altus[®] RTS

Solharo Type 1 & 2

Dimensions

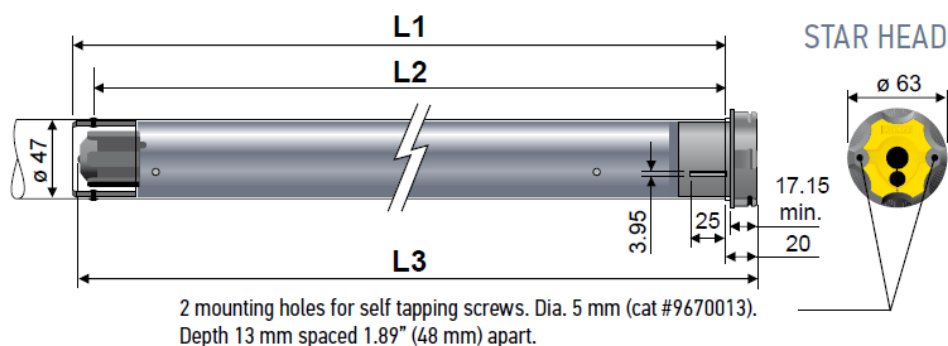

506	510	525	535	550
6 Nm	10 Nm	25 Nm	35 Nm	50 Nm
120V / 60HZ	120V / 60HZ	120V / 60HZ	120V / 60HZ	120V / 60HZ
1.1A	1.3A	1.6A	2.1A	2.1A
38 rpm	38 rpm	20 rpm	20 rpm	14 rpm



Solharo Type 3

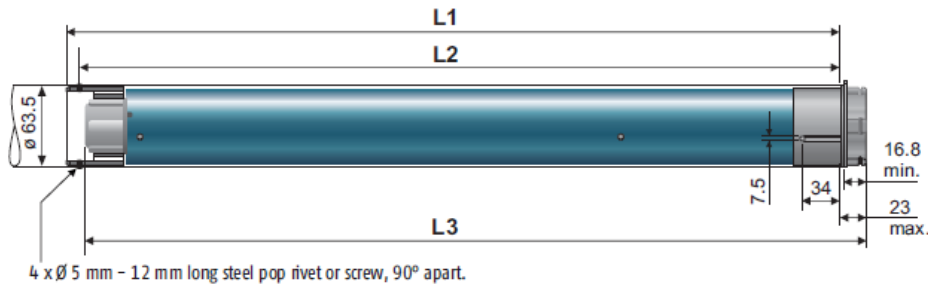

LT60 Altus RTS



LT60 Standard

Performances 660R2

Torque (in. lbs.)	60 Nm (530 in. lbs.)
Nominal Voltage	120V/60Hz
Rated Current	2.5A
Speed	14 rpm
Thermal Protection	4 minutes
Radio Frequency	433.42 MHz
Sound Level	≤ 63 dBA

Performances 660R2

Torque (in. lbs.)	60 Nm (530 in. lbs.)
Nominal Voltage	120V/60Hz
Rated Current	2.5A
Speed	14 rpm
Thermal Protection	5 minutes
Sound Level	≤ 63 dBA



Somfy TaHoma® RTS Smartphone and Tablet Interface

The Somfy TaHoma® gateway and smart phone app provides convenient and customized control of Somfy powered motorized shades, blinds, and other motorized solutions. Control up to 40 RTS (Radio Technology Somfy) channels using the TaHoma app. Multiple TaHoma devices can be joined for multi-zone control.



- North America app, you can remotely activate both Zigbee and RTS products Supports UP/DOWN/MY/STOP commands for motorized shades/blinds .
- Supports incremental control for Tilt motors and lighting ☑ Supports ON/OFF commands for control of lighting or other devices powered via the Zigbee Smart Plug Multiple users .
- Remote access Control4® Certified ☑ Integration with third-party systems over IP ☑ Compatible with Somfy Synergy™ API



TaHoma® RTS



Bond Home / Smartphone and Tablet Interface

Bond Bridge and Bond Bridge Pro works as a bridge between Wi-Fi and your remotes recorded signal allowing you to operate your Sunair shades, awnings, pergolas, ceiling fans, fireplaces and more with the Bond app. Works with Somfy and other motor manufacturers.



Remote control from anywhere

Be able to control everything even from outside your home.



Bond Bridge

- Works with Alexa, Google Home, and SmartThings,
- Remote Control via Bond Home app
- Works with iPhone or Android
- No installation needed
- Smart home functionality without breaking the bank

Bond Bridge Pro: *Added features...*

- Ethernet port & PoE technology
- Smart home integrations
- Ceiling and wall mount

OPTIONAL:

- Sidekick for Shades: 5-channel Shade and awning

BOND REMOTE SWITCH:

Sidekick for Shades/Awnings: 5-channel Shade Keypad



- Wireless flush mount shade remote.
- Communicates directly with the shade.
- 10-year battery life.
- Set up shade limits – no manufacturer remote required.
- This version of Sidekick does not support Scene Keypad functionality.
- 10-year battery life.
- Install with or without a workbox (flush mount).
- 5-channel control.
- Set up shade limits – no manufacturer remote required.



Notes

**Note: Sunair® reserves the right to change engineering, specifications and prices without notice.
Images and Illustrations in the catalog may vary from digital and printed manuals.**

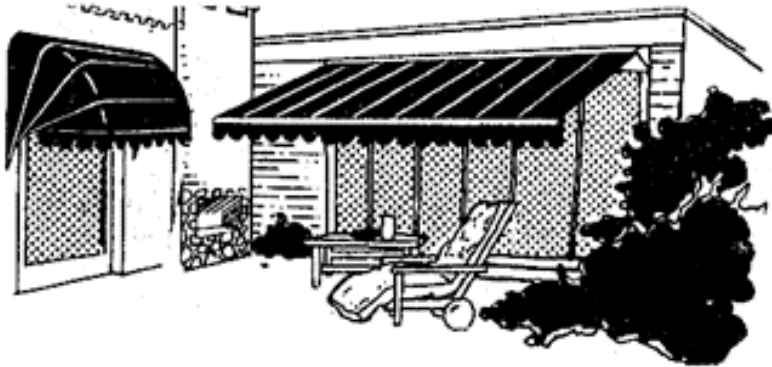

SUNPROOFING AMERICA!



MARYLAND LOCATION

Mailing: P.O. Box 1068
Shipping: 7785 Rt. 175
Jessup, MD 20794

Toll Free 800 - 548 - 0408
Phone: 410 - 799 - 1145
Fax: 410 - 799 - 5584

ARIZONA LOCATION

Mailing: Same as Jessup
Shipping: 3807 West Thomas Rd.
Phoenix, AZ 85017

Toll Free 877 - 272 - 3920
Phone: 602 - 272 - 3920
Fax: 602 - 272 - 3925

www.sunairawnings.com

info@sunairawnings.com