



SC4500/4600 MASTERSHADE®

Exterior Rolling Zipper Screen / 5" Cassette

The SC4500 is an exterior rolling zipper shade which can be used for sun and insect control or used with clear vinyl windows for light weather protection. The SC4600 can go wider using the same box to 24' wide but is only available with mesh limited in height to 9' high. The fabric runs inside vertical zippered guide tracks by means of gravity. A specially designed horizontal weighted hem bar keeps the fabric taut. The SC4500/SC4600 box is 5 3/16" deep, and 5 1/4" high. The SC4500 is also ideal for use with some Pergola® model awning systems as side screens to create an enclosure.

Type	Standard Frame Colors	Standard Widths	Standard Heights	Recommended Applications	Recommended Fabrics
Screen Exterior Retractable	9 standard Sunair colors	Through 20' /24' wide Depending on height and Fabric Type	Through 16' high Depending on width, Fabric & Type <u>SC4600 max</u> <u>Height 9 ft.</u>	Residential and commercial restaurant porches and lenai	Various Mesh & Ferrari 502 vinyl fabric

- Compact design box screen.
- Zipper retention system for fabric.
- Two sizes of zipper available standard
- Ideal with mesh fabric or vinyl fabric and windows.
- Optional "U" channels available for easy installation on uneven walls and columns.
- Gear or Motorized operation.
- Cassette mounts to ceiling or wall without brackets.

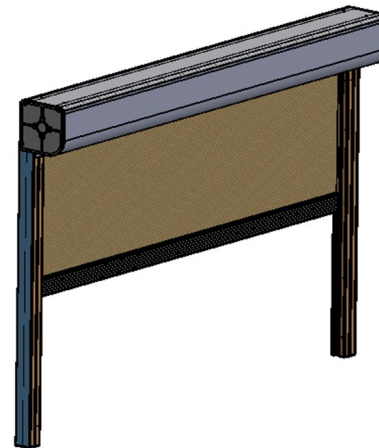

REVISED 02/15/2023

SC4500 Mastershade® Installations





Hem bar:
Front view 2" High
3/4" Wide front to back

Available Hem Bar
 Brush
 1/2" , 1" , and 1 1/2"

Track

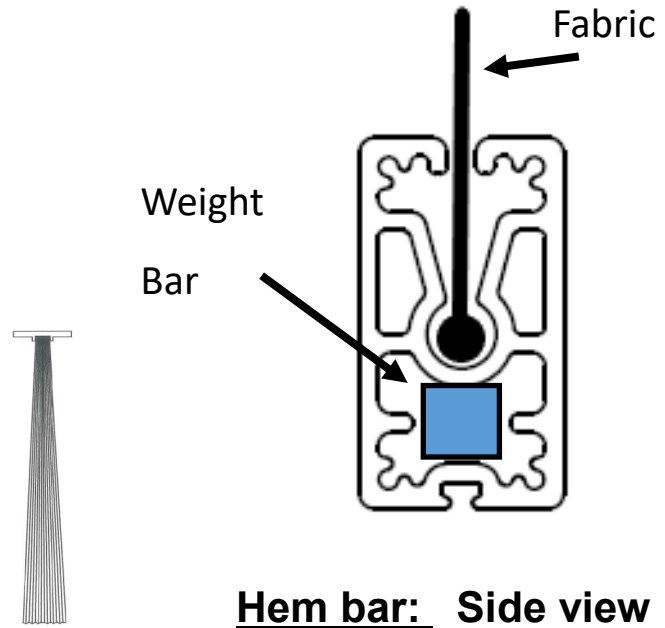

Hem bar: Side view

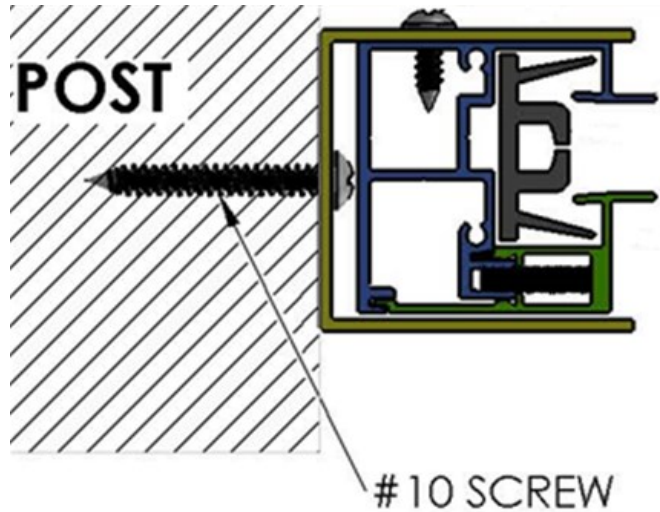

POST

#10 SCREW

Track with optional "U" channel can be added if mounting between columns. The U channel is typically only used if either top opening or bottom opening between columns is more than the other.

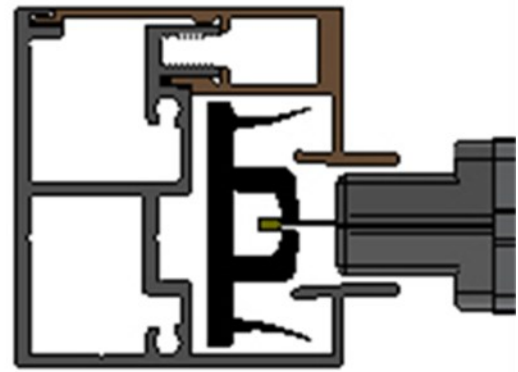

Standard track with zipper and track assembly.

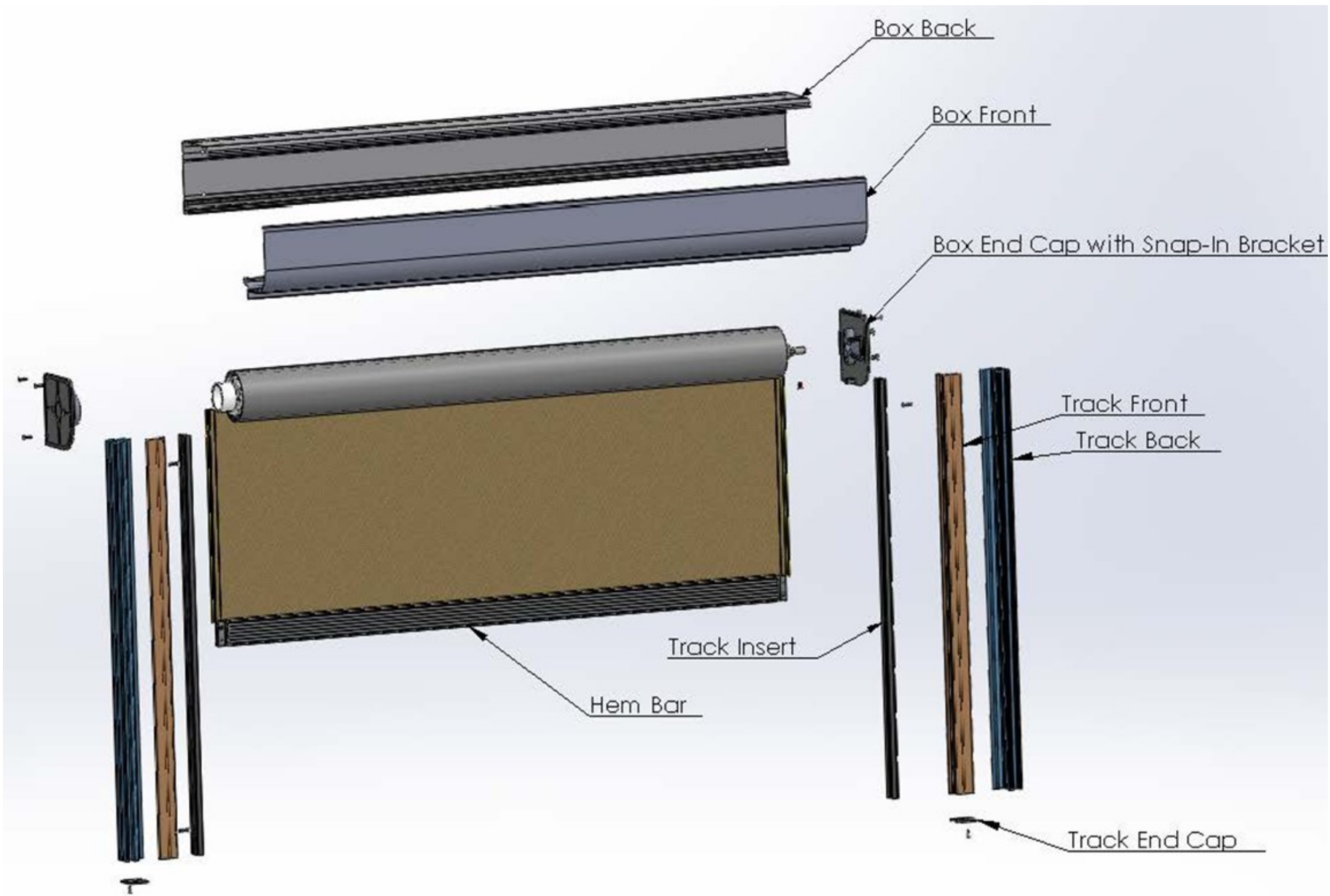

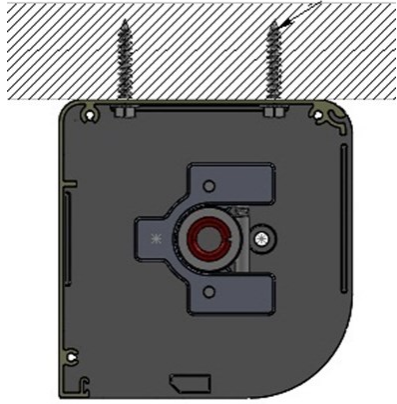

Ceiling or wall mounting cassette possible.

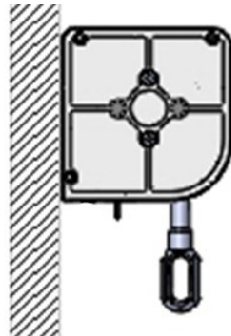
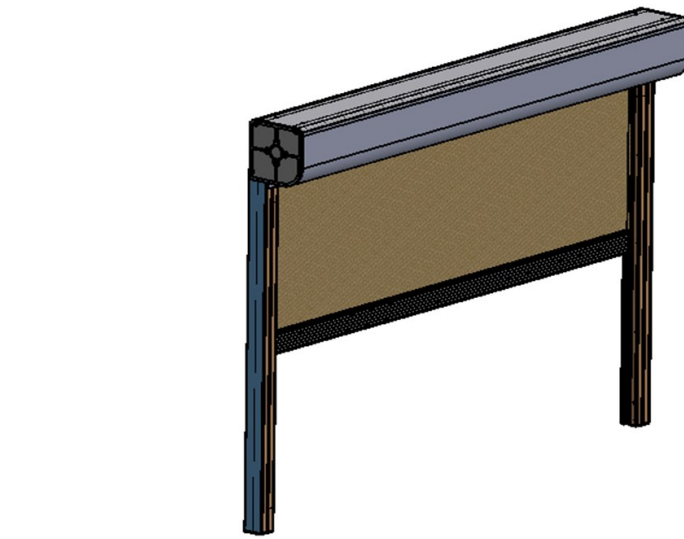
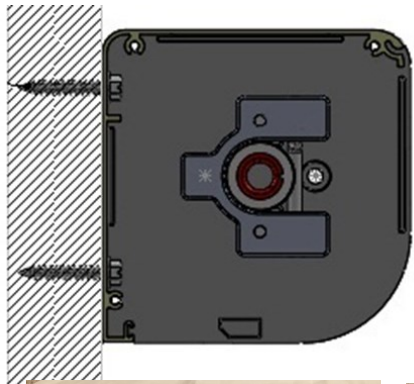

Front standard gear loop.



Back of cassette gear loop.

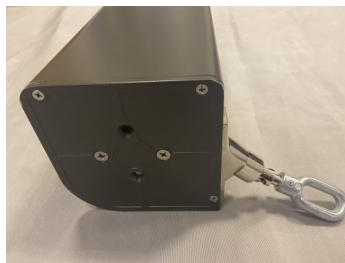

Ceiling mount only.

TYPICAL WALL MOUNT

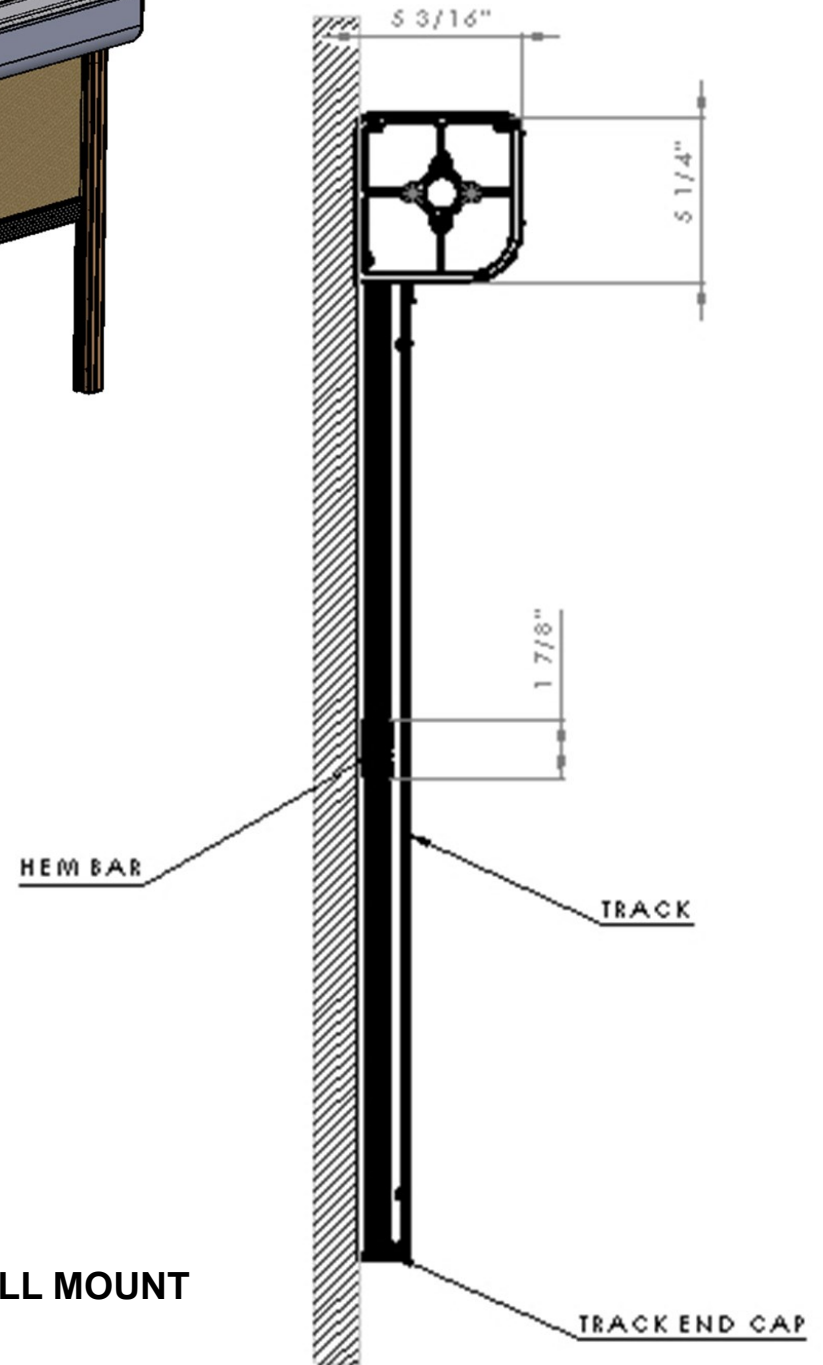

SC4500 SCREEN WITH ZIPPER

SC4500 FEATURES:

SUNAIR BENEFIT

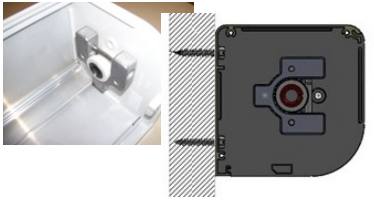
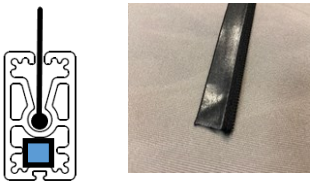
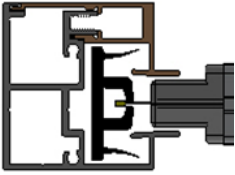
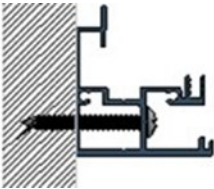
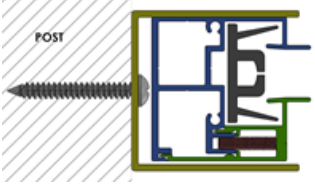
<p>Easy to remove roller tube and install cassette on wall or ceiling</p>		<p>SC3569M metal idler bracket for removing roller assembly. Re-enforced cassette with ridges for using smaller screws to install cassette.</p>	<p>The metal idler bracket makes it easy to remove roller tube and fabric and the cassette can be installed without use of brackets. It is designed to withstand the torque of larger heavy shades.</p>
<p>New Improved hem bar and optional larger zipper</p>		<p>Hem bar with internal weight bar hides the weld seams. Optional two sizes of zippers #2 and larger #3 sizes available.</p>	<p>An internal weight bar will not be exposed to the elements and the weld seam is hidden. The optional larger #3 sized zipper is advantageous for windier areas and larger screens.</p>
<p>Internal PVC zipper insert with winglets</p>		<p>The SC4500 "Zipper" insert PVC has soft "winglets" on each side of the zipper channel.</p>	<p>Vinyl winglets on the insert PVC provide tension while offering flexibility to expand and contract for the fabric as the temperature changes.</p>
<p>Easily installation of track to wall or side</p>		<p>The SC4500 track is easily attached to the back wall or side wall using small screws rather than track brackets (Back wall shown).</p>	<p>Eliminating track brackets makes for a faster installation and a cleaner look.</p>
<p>U channel for un-even wall installation</p>		<p>The "U" channel can be added to the standard track.</p>	<p>This "U" channel makes it easier to install the tracks between uneven columns or inserting into columns for new construction.</p>

MEASURING

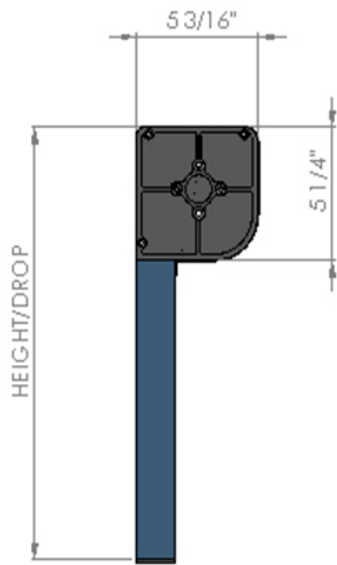

Width: Determine the desired width. The width of the screen is the measurement outside of track to outside of track and outside of cassette to outside of cassette end caps, as both are flush with each other. The track is 1 13/16" wide on each side (See Figure 1). The cassette mounts without using any brackets right on the wall or ceiling. If you mount the tracks on wood trim that protrudes out from the wall, the back of the cassette will have to be built out as well so that it becomes flush with the back of the tracks. The tracks also install right on the wall or post surface with screws (See sketch on next page).

CEILING MOUNTING BETWEEN PILLARS: If mounting under a patio or ceiling mounting, the height is not adjustable and height is total height of opening. Use gasket or bigger brush to make up difference in height from side to side. If mounting between pillars use the narrowest dimension and deduct 1/8" to 1/4" at top so cassette fits snug with minimal gaps on sides. If there is a very little difference on the width from top to bottom, you may be able to choose the narrowest and install the tracks right to the column and caulk. If distance is bigger, you should add U channels. If ordering the "U" Channels Sunair, will reduce the width of the fabric and hem bar by 3/4" to allow for the installation of the U channels with about 3/8" play on each side (see drawing next page). Sunair will not reduce the width of the cassette, only the width of fabric, zipper tracks, and hem bar. If the opening is wider at bottom, add U channels to compensate. If opening is no more than 1/2" narrower at bottom the 3/4" deduction on the fabric as per above for U channels will be sufficient. If opening at bottom is more than 1/2" narrower, add U channels, and direct on order for Sunair to deduct 1" on the fabric instead of 3/4" to compensate for U channels and have room for the screws. Sunair can deduct more on fabric if needed, please indicate on order. Commonly, if difference from top to bottom is very small it is common to order only 1 each U channel instead of two for both sides, with smaller deduction.

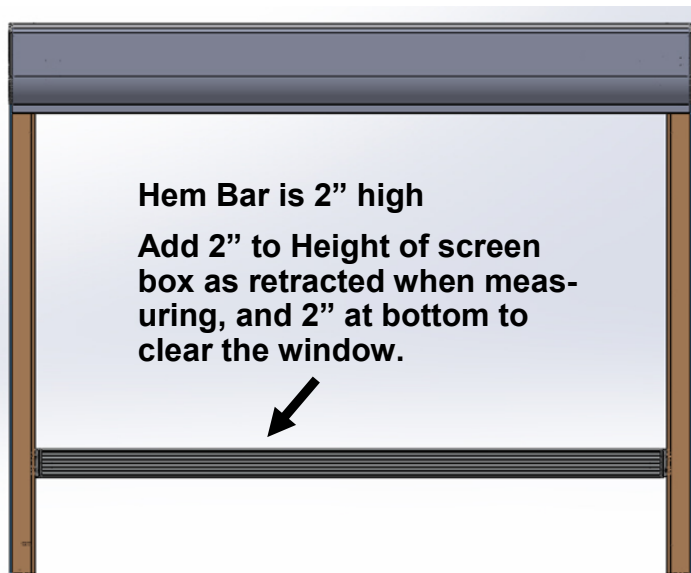

WALL SURFACE MOUNTING:

If mounting in front of a window opening, add at least 4" to the width of the opening or glass area to fit the screen. If surface mounting determine the height of the opening or window.

HEIGHT:

The fabric or screen mesh should cover the height of the window. The height of the screen includes the cassette height. To calculate the height of the shade if surface mounting to front wall consider adding the height of the cassette (5 1/4") plus 4" (2" at top and 2" at bottom) to the total height of opening to be covered (see sketches on left). This way, the hem bar is not seen while shade is retracted or lowered. Also watch out for casement windows that will interfere with the hem bar when the shade is retracted (In such a case, mount the top of the cassette 7 1/2" - 8" above the opening window edge). In addition, add 2" at the bottom, so the lowered hem bar goes past the glass edge.

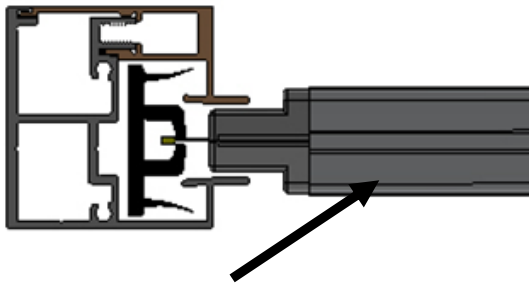

Hem bar: Top view
 $\frac{3}{4}$ " wide front to back

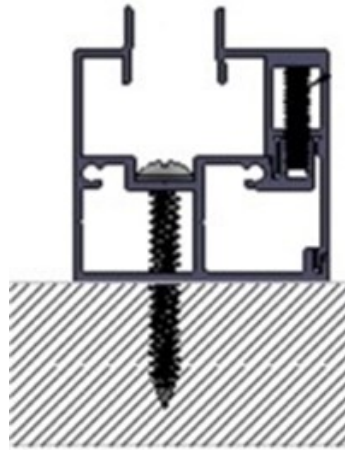

SIDE MOUNTED TRACK

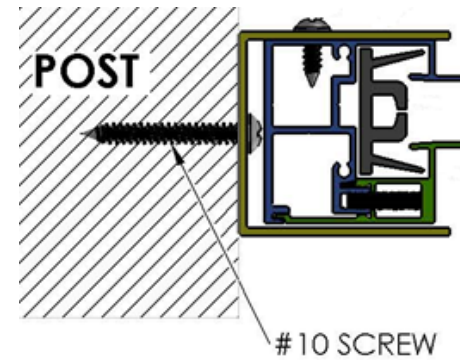

SIDE MOUNTED TRACK WITH U CHANNEL

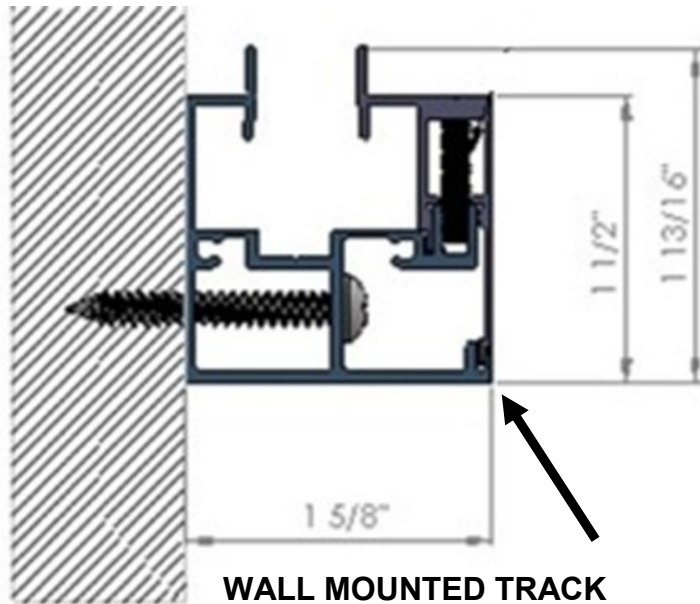

WALL MOUNTED TRACK

If using the "U" Channels, Sunair will reduce the width of the fabric and hem bar (Not cassette) to allow for the installation of the U channels between pillars with about $\frac{3}{4}$ " - 1" (Allowing for $\frac{3}{8}$ " to $\frac{1}{2}$ " play on each side). This takes into consideration the screw and wall thickness of the actual U channel so screen can be installed. Unless deductions were made in production, U channels cannot be added later.

BENEFITS OF SOLAR SCREENS



Screen fully lowered down

- **Reduces indoor temperatures and saves energy cooling your space.**
- **Cuts down on solar glare while retaining your view depending on mesh fabric type and openness factor.**
- **Cuts down on interior fading of floors, carpets and furniture.**
- **Can offer complete black out privacy blocking all light.**



Screen partially lowered down



Screen partially down showing glare



Screen fully down and no glare

BENEFITS OF SOLAR SCREENS cont:

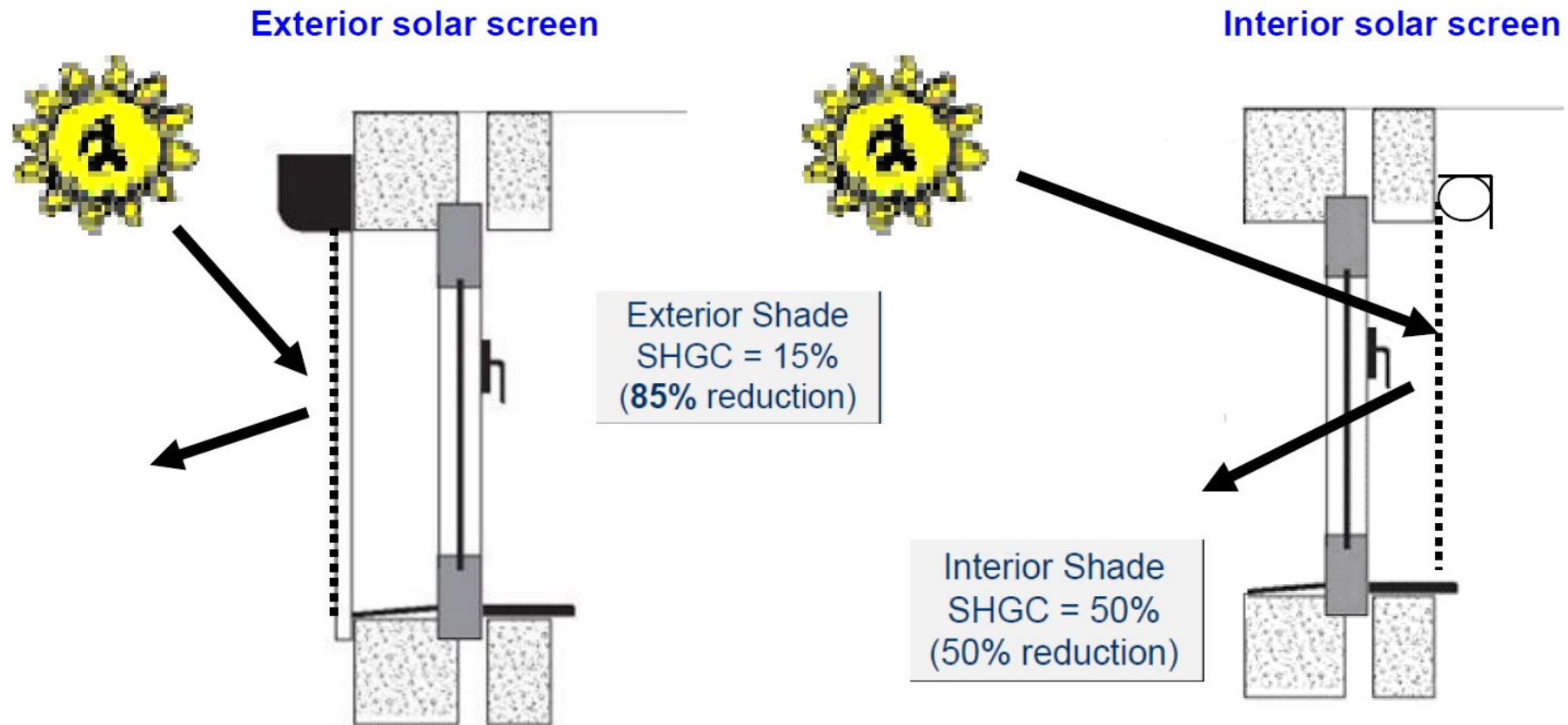

Solar screens can be installed both on the exterior and interior applications of residential and commercial spaces. The benefit with exterior solar screens is that the fabric blocks the sun before it enters the home or space through the glass. Sometimes it is not feasible to install an exterior screen. In such a case, interior screens offer a good alternative. Interior screens are also more economical.

BENEFITS OF EXTERIOR SOLAR SCREENS:

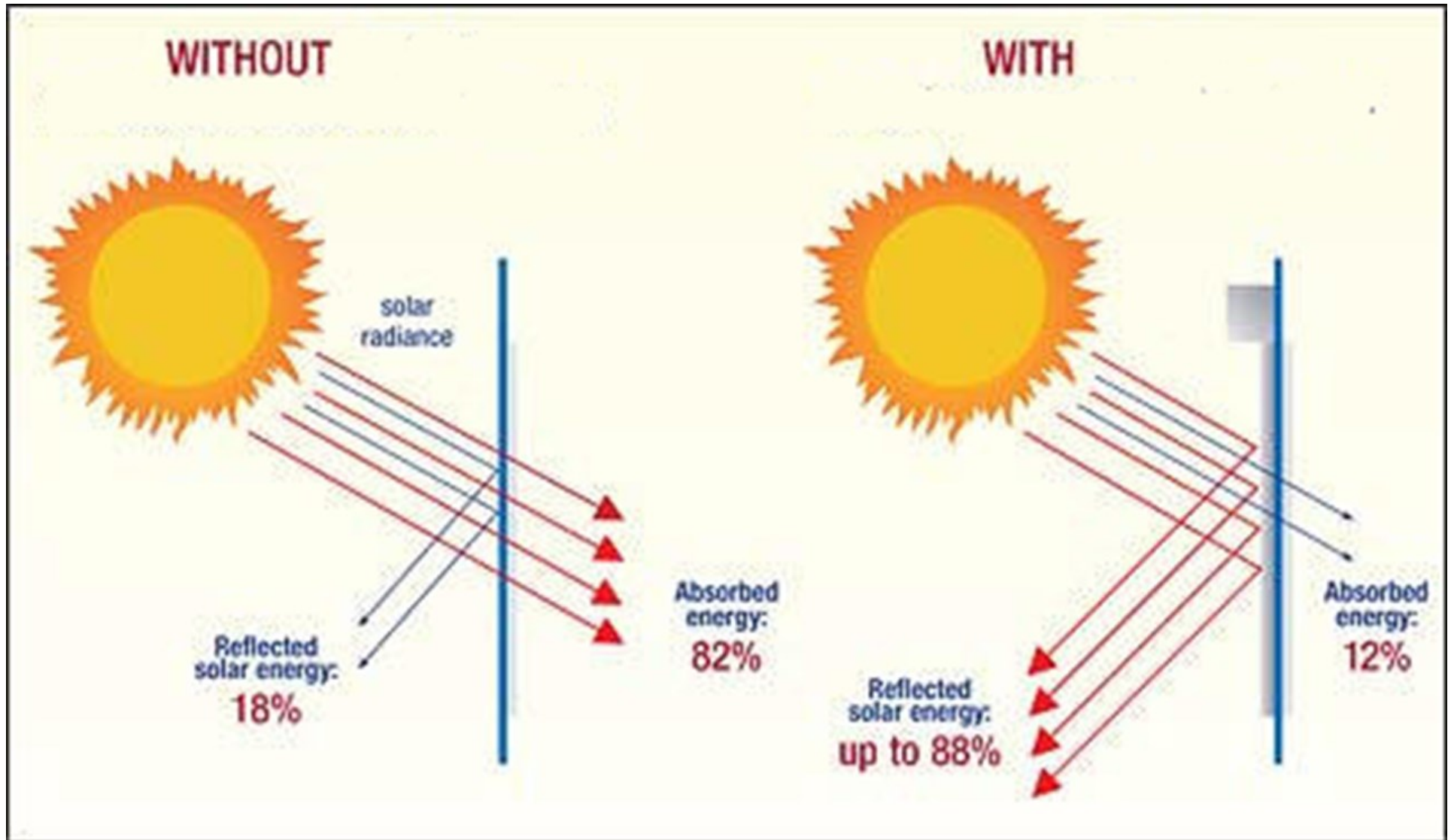

BENEFITS OF ZIPPER SCREENS WITH MESH



- **Creates an instant screened in porch with the ability to revert to a full open porch when desired.**
- **Zipper fabric retention will keep pesky bugs at bay when using a closed mesh fabric.**
- **Reduces patio temperatures and keeps your space cooler.**
- **Cuts down on solar glare while retaining your view depending on mesh fabric type and openness factor.**
- **Cuts down on interior fading of floors, carpets and furniture.**



BENEFITS OF ZIPPER SCREENS WITH WINDOWS



- Great for residential and commercial spaces like restaurants.
- Creates an instant enclosed space by lowering the shades.
- Keeps moderate weather at bay by keeping rain and moderate winds from reaching the space.
- Adding heaters will heat the space and make it usable during cooler months.



FRAME COLORS (STANDARD)

Screens*

*Note: See each model technical page for available frame colors. Available interior screen colors are different than depicted below (see Interior screens).

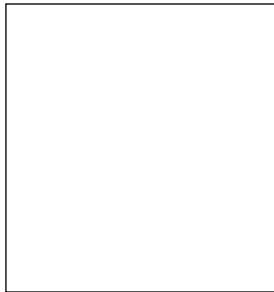

WHITE Gloss
Ral 9010

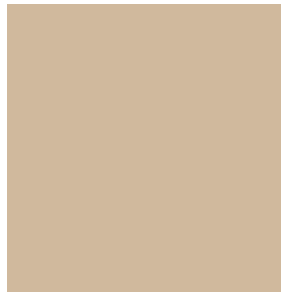

MOCHA
Semi Gloss

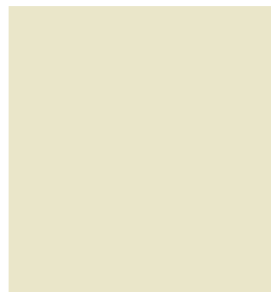

**DESERT SAND /
IVORY Gloss**



BLACK Gloss
Ral 9005



BRONZE
Coarse



GREY Gloss
Ral 7040

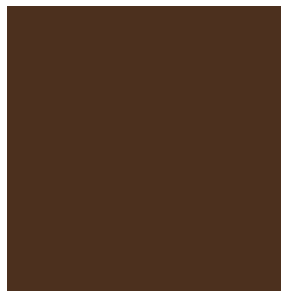

BROWN Gloss

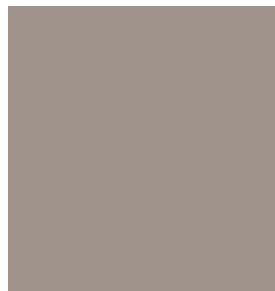

TAUPE Gloss



GREEN Gloss
Ral 6005

OPTIONAL

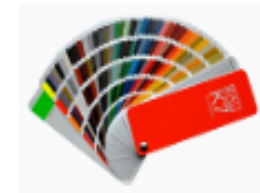

**FULL RAL COLOR
RANGE / EXTRA COST**

NOTE: All these colors except Green Ral 6005 and Desert Sand / Ivory are “super durables” which offer better durability compared with standard polyesters powders.

NOTE: ACTUAL FRAME COLOR MAY VARY FROM DIGITAL IMAGES





TEMPOTEST
ITALIAN PERFORMANCE FABRICS



ACRYLIC FABRIC COLLECTION



Fabric covers sewn with Tenara thread.



5 Forest Green



7 Moss Green



8 Medium Green



11 Red



12 Yellow



13 Ocean Blue



14 Toast

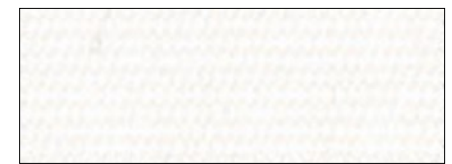

15 White



24 Black



33 Forest Green / White



35 Red / White



37 Yellow / White



47 Brown / Stone

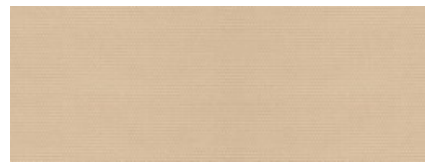

52 Tan



53 Pale Peach



73 Burgundy



75 Navy Blue



79 Grey



81 True Brown



84 Dark Terracotta

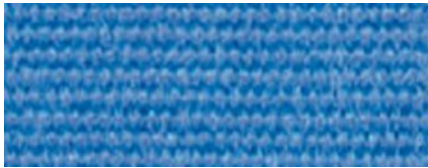

87 Fancy Blue



101 Elite Toast



102 Cappuccino



106 Toffee

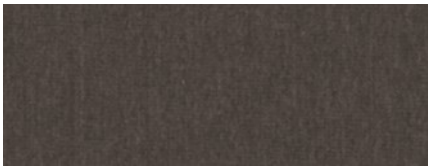

107 Textured Dk. Grey



242 Grey / White

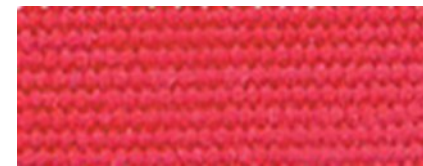

426 Terracotta



439 Dark Grey / White



809 Cream / Green



878 Beige / White Speckled



926 Taupe Classic Solid

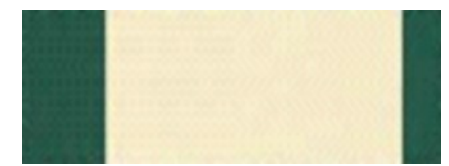

931 Green / Cream Wide



969 Grey Fancy Stripe

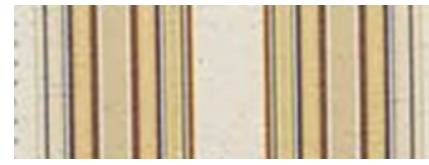

1101 Beige / Stripe Fancy



1120 Brown/ Beige Fancy



1150 Rust / Green Multi



116/15 Medium Blue / White



1243 Yellow Multi



1302 Sage Tweed



1330/512 Carbon Stitch



15/1 Beige



15/14 Raw



15/79 Stone



4015/91 Raw Speckled



407/11 Burgundy Tweed



407/13 Blue Tweed



407/14 Toast Classic Tweed



407/16 Moss Classic Tweed



407/3 Green Classic Tweed

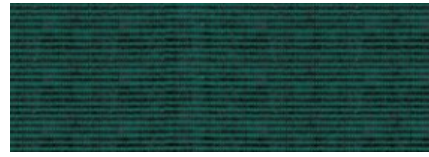

407/6 Green Tweed



407/79 Pepper Grey



407/926 Grey Classic Tweed



4215/15 Textured Tan



5000/57 Cocoa Stripe



5001/1 Green Graduated



5001/13 Blue Graduated



5001/7 Moss Graduated



5001/73 Burg/Grey Graduated



5009/1 Beige / Tan Stripe



5009/14 Brown / Tan Stripe



5011/11 Brick/Natural Fancy



5011/57 Tan / Brown Fancy



5011/7 Tan / Green Fancy



5071/7 Natural/Moss Graduated



5072/86 Brown/Stone Fancy



5118/62 Yellow / White Fancy



5144/14 Pastel/Natural Fancy



5167/11 Red / Grey Fancy



5167/2 Blue / Grey Fancy

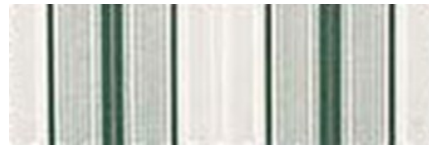

5167/5 Green / Grey Fancy



5173/12 Yellow / Grey Stripe



5304/15 Rose / Grey Fancy



5347/58 Grey Wheat Multi



5347/79 Platinum Grey Multi



5348/58 Beige / Wheat Multi



5348/79 Grey / Slate Multi



5349/106 Brown Cream Stripe

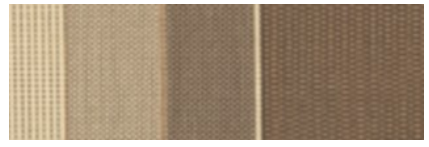

5349/930 Beige / Brown Classic

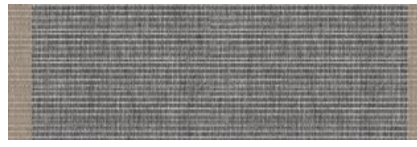

5369 Charcoal / Brown



5370 Beige / Grey



5371/727 Grey / Black Stripe



5374 Smoke / Grey Stripe

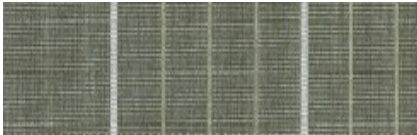

5396/78 Green Tweed Stripe

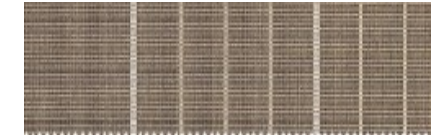

5396/930 Hazelnut Stripe



5396/97 Charcoal Tweed Stripe



5397/97 Grey / Black Graduated

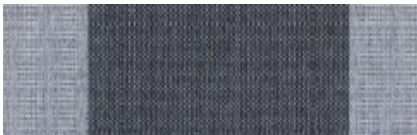

5398/107 Carbon Blue Blend

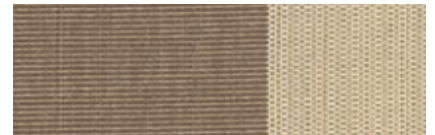

5398/930 Dune / Brown Striped

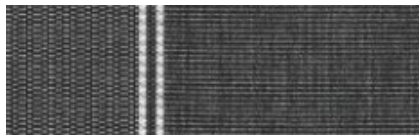

5399/107 Drk. Grey Tweed

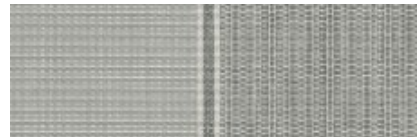

5399/15 Lgt. Grey Stripe

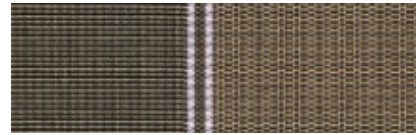

5399/52 Sesame Tweed
Stripe



5399/94 Stone / Grey
Tweed



5406/52 Coriander Tweed

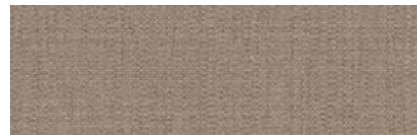

5406/94 Textured / Desert
Beige

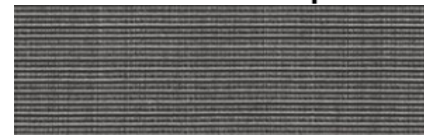

5407/107 Charcoal /
Stone Tweed



5407/15 Textured Silk
Grey

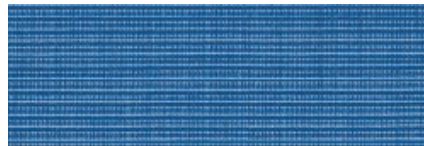

5407/17 Sky Tweed



5407/52 Sesame Tweed



5407/94 Desert Grey
Tweed



633/79 Grey/ Black Fancy



634/51 Grey / Natural Fancy



634/97 Green / Tan Fancy



635/11 Cranberry/Natural F.



636/10 Grey / Blue Graduated



636/12 Yellow Graduated



636/14 Brown Elite Stripe

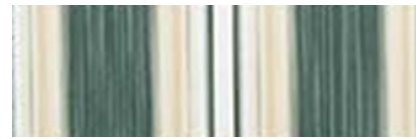

636/5 Green / Beige Fancy



636/84 Terracotta Graduated



638/5 Green Grey Fancy



639/99 Tan / Natural Fancy



641/10 Blue / Beige Fancy

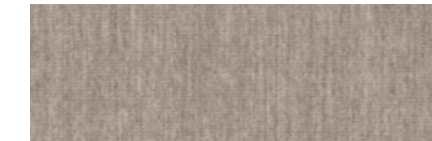

727/15 Textured Med. Grey



739/701 Sage / Beige Fancy



769/75 Cream / Blue Fancy



**782/14 Beige Classic
Solid**

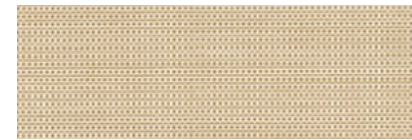

873/151 Dune Tweed

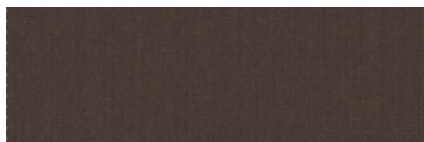

873/2 Textured Cocoa



939/94 Grey Elite Stripe



940/5 Green Elite Stripe



947/14 Pale / Beige Classic



**949/91 Brown Beige
Classic**

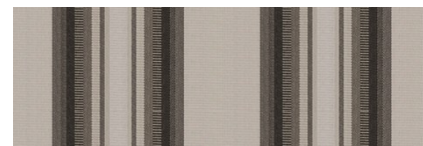

**950/24 Grey / Charcoal
Classic**

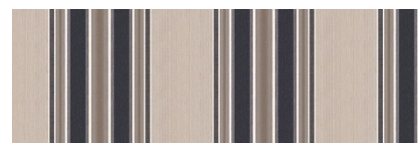

**951/92 Grey / Navy
Classic**



967/926 Grey/Charcoal Elite



**968/426 Terracotta Cream
Fancy**



97/84 Plum

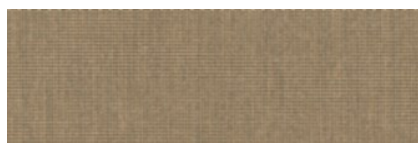

986/106 Textured Beige



986/15 Textured Lt. Grey



**986/727 Textured Pebble
Grey**

SOLIDS · TWEEDS · BLOCK STRIPES · FANCY STRIPES · GRADUATED STRIPES

5	Forest Green	407/14	Toast Classic Tweed	5406/52	Coriander Tweed
7	Moss Green	407/16	Moss Classic Tweed	5406/94	Textured Desert Beige
8	Medium Green	407/3	Green Classic Tweed	5407/107	Charcoal/Stone Tweed
11	Red	407/6	Green Tweed	5407/15	Textured Silk Grey
12	Yellow	407/79	Pepper Grey	5407/17	Sky Tweed
13	Ocean Blue	407/926	Grey Classic Tweed	5407/52	Sesame Tweed
14	Toast	4215/15	Textured Tan	5407/94	Desert Grey Tweed
15	White	5000/57	Cocoa Stripe	633/79	Grey/Black Fancy
24	Black	5001/1	Green Graduated	634/51	Grey/Natural Fancy
33	Forest Green/White	5001/13	Blue Graduated	634/97	Green/Tan Fancy
35	Red/White	5001/7	Moss Graduated	635/11	Cranberry/Natural Fancy
37	Yellow/White	5001/73	Burgundy/Grey Graduated	636/10	Grey/Blue Graduated
47	Brown/Stone	5009/1	Beige/Tan Stripe	636/12	Yellow Graduated
52	Tan	5009/14	Brown/Tan Stripe	636/14	Brown Elite Stripe
53	Pale Peach	5011/11	Brick/Natural Fancy	636/5	Green/Beige Fancy
73	Burgundy	5011/57	Tan/Brown Fancy	636/84	Terracotta Graduated
75	Navy Blue	5011/7	Tan/Green Fancy	638/5	Green/Grey Fancy
79	Grey	5071/7	Natural/Moss Graduated	639/99	Tan/Natural Fancy
81	True Brown	5072/86	Brown/Stone Fancy	641/10	Blue/Beige Fancy
84	Dark Terracotta	5118/62	Yellow/White Fancy	727/15	Textured Medium Grey
87	Fancy Blue	5144/14	Pastel/Natural Fancy	739/701	Sage/Beige Fancy
101	Elite Toast	5167/11	Red/Grey Fancy	769/75	Cream/Blue Fancy
102	Cappuccino	5167/2	Blue/Grey Fancy	782/14	Beige Solid Classic
106	Toffee	5167/5	Green/Grey Fancy	873/151	Dune Tweed
107	Textured Dark Grey	5173/12	Yellow/Grey Stripe	873/2	Textured Cocoa
242	Grey/White	5304/15	Rose/Grey Stripe	939/94	Grey Elite Stripe
426	Terracotta	5347/58	Grey/Wheat Multi	940/5	Green Elite Stripe
439	Dark Grey/White	5347/79	Platinum Grey Multi	947/14	Pale Beige Classic
809	Cream/Green	5348/58	Beige/Wheat Multi	949/91	Brown/Beige Classic
878	Beige/White Speckled	5348/79	Grey/Slate Multi	950/24	Grey/Charcoal Classic
926	Taupe Classic Solid	5349/106	Brown/Cream Stripe	951/92	Grey/Navy Classic
931	Green/Cream Wide	5349/930	Beige/Brown Classic	967/926	Grey/Charcoal Elite
969	Grey Fancy Stripe	5369	Charcoal/Brown	968/426	Terracotta/Cream Fancy
1101	Beige/Stripe Fancy	5370	Beige/Grey	97/84	Plum
1120	Brown/Beige Fancy	5371/727	Grey/Black Stripe	986/106	Textured Beige
1150	Rust/Green Multi	5374	Smoke/Grey Stripe	986/15	Textured Light Grey
116/15	Medium Blue/White	5396/78	Green Tweed Stripe	986/727	Textured Pebble Grey
1243	Yellow Multi	5396/930	Hazelnut Stripe		
1302	Sage Tweed	5396/97	Charcoal Tweed Stripe		
1330/512	Carbon Stitch	5397/97	Grey/Black Graduated		
15/1	Beige	5398/107	Carbon Blue Blend		
15/14	Raw	5398/930	Dune/Brown Stripe		
15/79	Stone	5399/107	Dark Grey Tweed		
4015/91	Raw Speckled	5399/15	Light Grey Stripe		
407/11	Burgundy Tweed	5399/52	Sesame Tweed Stripe		
407/13	Blue Tweed	5399/94	Stone/Grey Tweed		





RecScreen
5000P

Exterior Screen Fabric



300 Charcoal / Charcoal

Specifications

Composition: 15% Polyester, 85% Vinyl

Syle: Basket Weave

Mesh Weight: 14,75 (oz/yd²)

Openness Factor: 5.5 %

Fabric Thickness (in): .026

Width: 118"

Fire classification: NFPA 701 Test 1, and CA Fire Marshall Title 19, Section 1237.1

Warranty: 5 years exterior

Bacteria and Fungal Resistance: AATCC Test Method 100-2004



001 White
/ Linen



002 Blanco
/ Sable

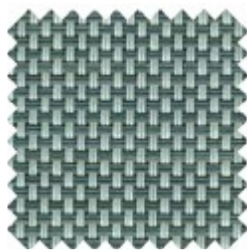

405 Pearl
/ Dark Grey



305 Charcoal
/ Dark Grey



307 Charcoal
/ Bronze

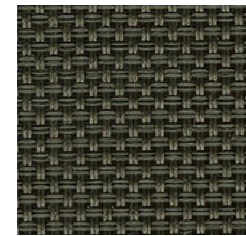

770 Bronze
/ Bronze

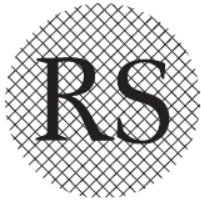

RecScreen

6000P



300 Charcoal / Charcoal

Specifications

Composition: 18% Polyester, 82% Vinyl

Style: Twill

Mesh Weight: 17,8 (oz/yd²)

Openness Factor: 3 %

Fabric Thickness (in): .78 mm

Width: 118"

Fire classification: NFPA 701 Test 1, and CA Fire Marshall Title 19, Section 1237.1

Warranty: 10 Year Limited. Visit www.recasensusa.com for full warranty.

Bacteria and Fungal Resistance: AATCC Test Method 100-2004



001 White
/ Linen



002 White
/ Sable

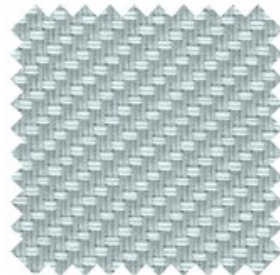

004 White
/ Pearl Grey

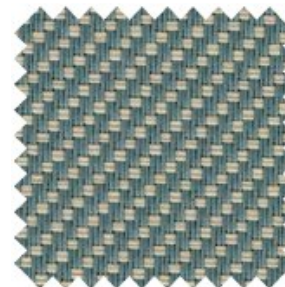

502 Dark
Gray / Sable



503 Dark
Gray / Charcoal



307 Charcoal
/ Bronze

Exterior Screen Fabric

NEW!
Natté™

Outdoor Screen Fabric.

42% Fiberglass

58% vinyl

3%, 5% , & 10%



3% 30M687 | Charcoal/Cocoa-Fawn



5% 30M687 | Charcoal/Cocoa-Fawn



10% 30M687 | Charcoal/Cocoa-Fawn



910902
Sable/White

10M127
Sable/Sable-Fog

910988
Sable/Wood

901910
Grey/Sable

30M687
Charcoal/
Cocoa-Fawn

930961
Charcoal/Cocoa

930992
Charcoal/Gamet

901901
Grey/Grey

901930
Grey/Charcoal

30M394
Charcoal/
Charcoal-Navy

930993
Charcoal/Forest

930930
Charcoal/
Charcoal



Sun Control Textiles™

Exterior Screen Fabric

NEW! **Satiné™**

Outdoor Screen Fabric.

42% Fiberglass

58% vinyl

1% & 5%



1% 30M394 | Charcoal/Charcoal-Navy



5% 30M394 | Charcoal/Charcoal-Navy



910988
Sable/Wood

10M986
Sable/
Garnet-Auburn

910993
Sable/Forest

30M687
Charcoal/
Cocoa-Fawn

930961
Charcoal/Cocoa

30M386
Charcoal/
Charcoal-Auburn

901994
Grey/Navy

30M394
Charcoal/
Charcoal-Navy

01M230
Grey/Fog-Charcoal

30M301
Charcoal/
Charcoal-Grey

930930
Charcoal/Charcoal

930992
Charcoal/Garnet



Sun Control Textiles™

PHIFER 40 % open
TuffScreen®

Standard Heavy-Duty Insect Screening

Exterior Screen Fabric
Zipper Screens only



Phifer TuffScreen®
is backed by a
10-year extended
limited warranty.



Specifications

Standard Color: Black

Standard Widths: 36" (91.4cm), 48" (121.9cm), 60" (152.4cm), 72" (182.9cm), 84" (213.4cm), 96" (243.8cm), 108" (274.3cm) and 120" (304.8cm)

Standard Roll Lengths: 100' (30.48m) in all widths and 50' (15.24m) in all widths except 120"

Packaging: Individually wrapped in protective paper



- Heavy-duty, vinyl-coated polyester insect screening
- Ideal for use in high-traffic areas
- Durable – resists damage from pets, tears and punctures
- Excellent choice for patios, porch enclosures, retractable systems, windows and doors

Exterior Screen Fabric
Zipper Screens only

PHIFER 45 % open
TuffScreen®
NO-SEE-UM



Phifer TuffScreen®
is backed by a
10-year extended
limited warranty.

Specifications

Standard Color: Black

Standard Widths: 36" (91.4cm), 48" (121.9cm), 60" (152.4cm), 72" (182.9cm), 84" (213.4cm), 96" (243.8cm), 108" (274.3cm) and 120" (304.8cm)

Standard Roll Lengths: 100' (30.48m) in all widths and 50' (15.24m) in all widths except 120"

Packaging: Individually wrapped in protective paper



- Heavy-duty, vinyl-coated polyester insect screening
- Ideal for use in high-traffic areas
- Durable – resists damage from pets, tears and punctures
- Excellent choice for patios, porch enclosures, retractable systems, windows and doors

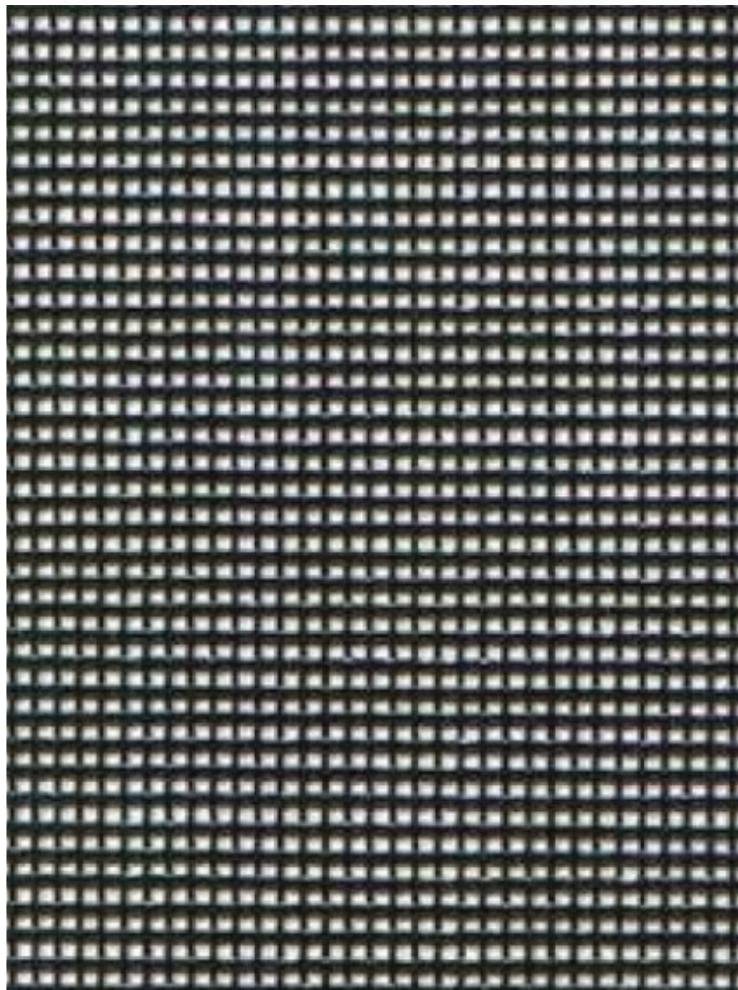

Soltis
Horizon 86

Serge Ferrari

14 % Open Screen Mesh

Exterior Screen Fabric

5 year warranty from Ferrari

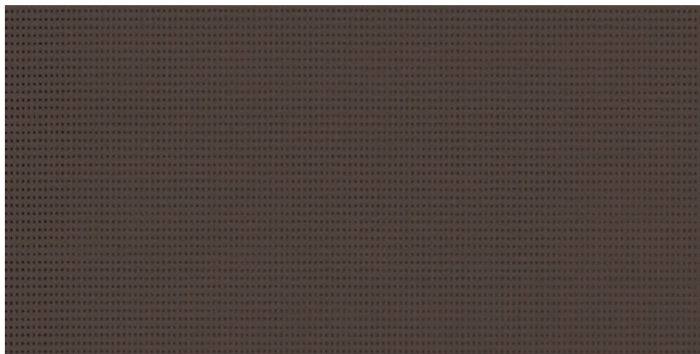

86-2043
Bronze

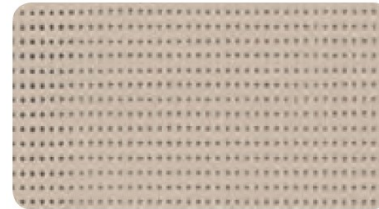

86 – 2135
Sandy Beige

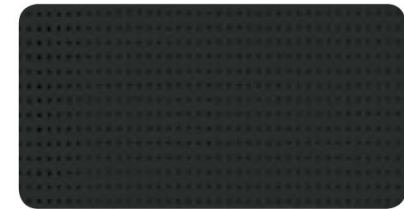

86 – 2053
Black

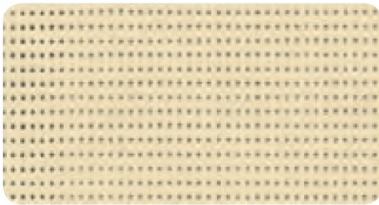

86 – 2175
Champagne

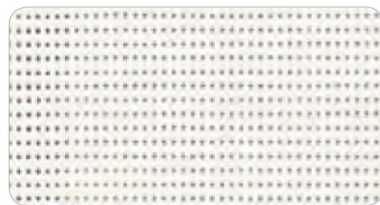

86 – 2044
White

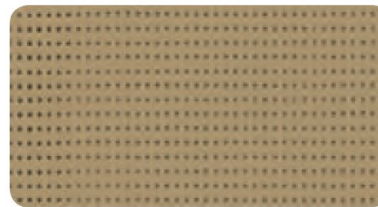

86 – 2012
Pepper



86 – 2171
Boulder

■ **Technical properties**

Openess factor	14%
Weight	380 g/m ² — 11.2 oz/sqyd
Thickness	0.45 mm — 450 microns
Width	177 cm - 267 cm — 69.7 in. - 105.1 in.

Superior elongation and tear resistance

No deformation during processing and use

Superior aesthetic and mechanical durability

Smooth finish easy to clean, space saving, easy rolling

Exterior Screen Fabric



5 % Open Screen Mesh

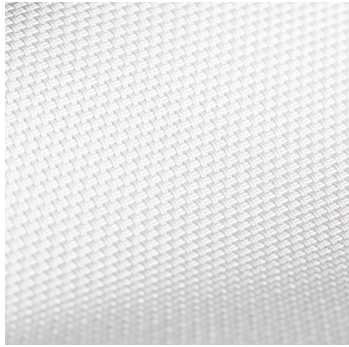

White



Stone Texture

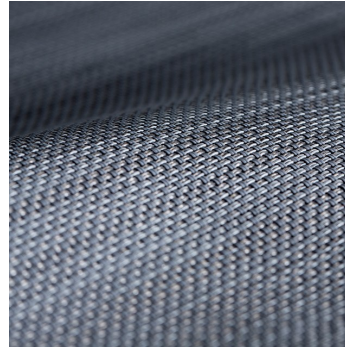

ShadowTexture



Granite

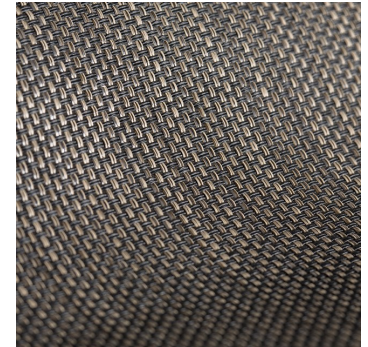

Espresso Texture

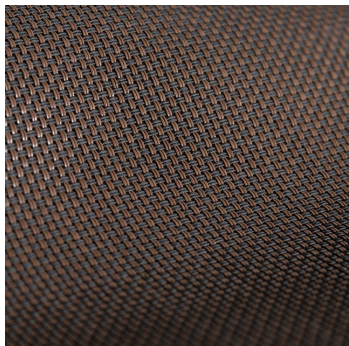

Tobacco

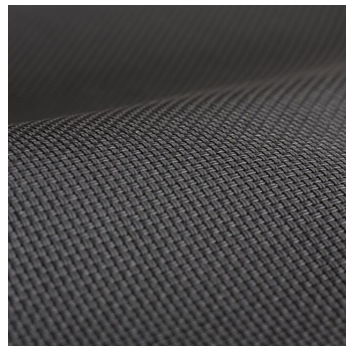

Charcoal

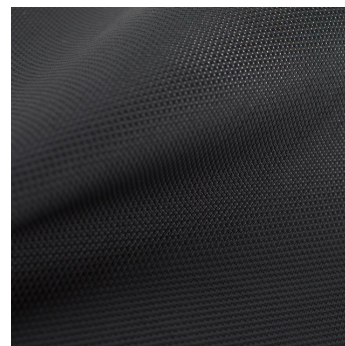

Flat Black



Bone

TEXTILENE® nano™ 95 is a durable, yet lightweight synthetic fabric. It is lighter and finer with the same technical qualities as the original TEXTILENE®. TEXTILENE® nano™95 is excellent for exterior use and can reduce energy costs while blocking up to 95% of the sun's harmful rays.



Exterior Vinyl Fabric Zipper Screens only

502 PROOF SOLTIS / OPAQUE SATINE FINISH COLORS

The Preconstraint 502 fabric from Ferrari also offers excellent dimensional stability with minimal stretching and exceptional dirt resistance thanks to a PVDF topcoat on both sides. The fabric is therefore perfect for use on retractable zipper screens with window film. The fabric is 16.8 oz / sq. yd. with a satin finish. Fabrics are fire retardant / certificate is available upon request.



satin finish

5 year warranty from Ferrari

Serge Ferrari

MOTORIZATION

POWERED by
somfy



Awnings



Exterior Screens



Pergolas



Roller/Solar Shades

Sunair is proud to offer the full line of Somfy motors and controls for our awnings and screens program. SOMFY RTS features motors with an integrated radio receiver that allows you to operate the awning by remote control with a wall mounted or hand held remote or by smart phone device. With a simple click of your remote, the awning or shade will extend or retract automatically. The manual override Sunea motor is ideal for awnings and the Altus motors is ideal for exterior screens. Each motor can be configured with a cord & plug which can simply be plugged into your patio outlet. They are available in 1.4", 11', 17', & 23' lengths. Altus motor cords depend on motor model and is standard either 6' or 10' pigtail cords. Optional Altus plug in cords are available in 10', 18', and 24' lengths. Optional screen motor is Maestria with obstacle detection. Add Tahoma smart phone and table interface.



ALTUS®

SOMFY REMOTES:



Telis 1 & 4 RTS
Hand-held Remotes



Situ 1 & 4 hand
held remotes

One (1) through (16) channel hand held or wall mounted remotes are available. Remotes are available in different colors to suit your style, please inquire.



Telis hand-held remotes offer convenient and simple operation of every type of motorized application. Channels help organize the motorized products that are operated. Single channel remotes can operate one individual product or one group of motorized products. Multiple channel remotes can handle groups of motorized products.



Telis 1 Chronis
RTS Timer



DecoFlex WireFree™ RTS
Wall Switches



Telis 1 Patio for
exterior use



Smooove® 1 RTS
Surface Mount Wall Switch



Telis 16 RTS
Hand-held Remote

AVAILABLE AUTOMATIC SENSORS & CONTROLS



SOLIRIS RTS 24V KIT

Sun & Wind Sensor

The Soliris RTS Sun and Wind Sensor automatically controls your RTS motorized products based on current weather conditions.



ONDEIS® WIREFREE

Sun & Rain Sensor

The Rain Sensor is a solar-powered combined rain and sun sensor compatible with Radio Technology Somfy® motorized exterior products, including awnings and screens.



**Sunis & ThermoSunis
Indoor WireFree™ RTS Sensors**



SOMFY MOTOR WIRING



Radio Technology Somfy

Radio Technology Somfy® (RTS) allows wireless radio control of motorized applications via the RTS family of controls.



The three (3) wire cords can be wired in parallel and can be ordered with a molded plug to simply plug into an exterior UL approved GFI outlet. The standard four (4) wire cords must be hard wired with a traditional toggle wall switch. Screens can not be ordered with molded plugs on the end.

Optional molded plug is available for "awning" motors only



Type of power cable **RTS plug in capable motor cord**

RTS
120V AC / 60Hz
3 conductor cable

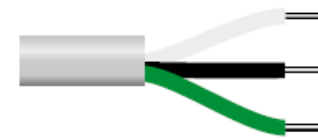

white = neutral
black = hot
green = ground

All Somfy Motors are UL and CSA Recognized

- All SOMFY motors are UL Recognized and can be found under the following file numbers:
E60495, E60888, E63714



Type of power cable **STANDARD Hardwire motor cord**

Wired
120V AC / 60Hz
4 conductor cable



white = neutral
red = direction 1
black = direction 2
green = ground

Hardwired motors with a wall switch

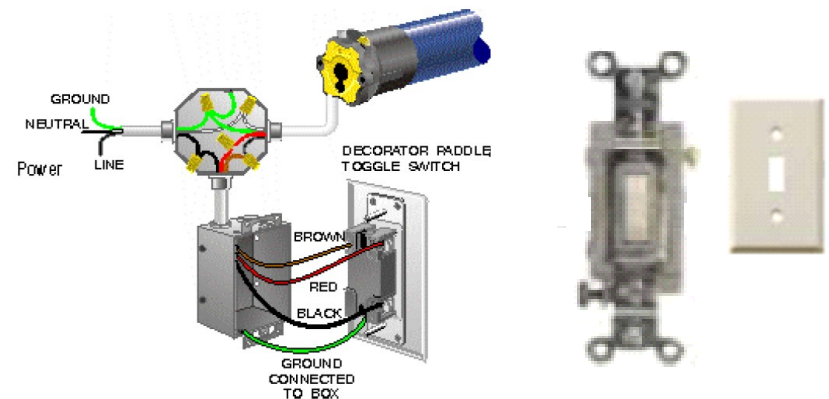

Dimensions

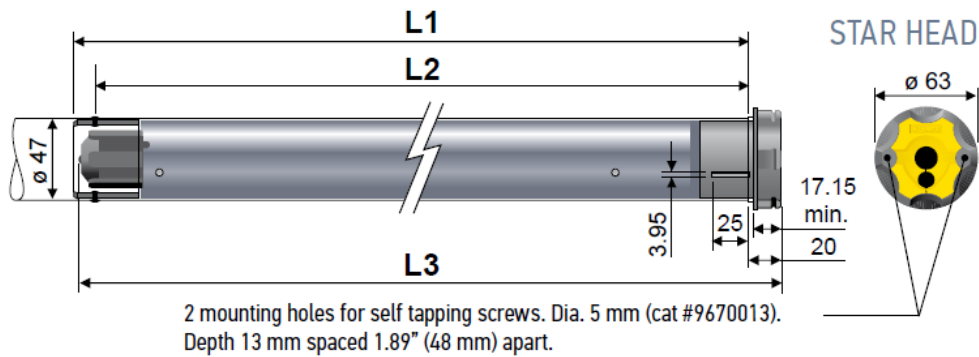

506	510	525	535	550
6 Nm	10 Nm	25 Nm	35 Nm	50 Nm
120V / 60HZ	120V / 60HZ	120V / 60HZ	120V / 60HZ	120V / 60HZ
1.1A	1.3A	1.6A	2.1A	2.1A
38 rpm	38 rpm	20 rpm	20 rpm	14 rpm

MAESTRIA OSTACLE

DETECTION EXTERIOR SCREEN MOTOR



The **SOMFY Maestria obstacle detection motor** is the recommended motor to be used for all zipper screens. These motors accurately detects obstacles, stopping after meeting an object traveling up or down. Protects carrier products and prevents fabric damage resulting from screen bunching and slipping from the guides. The motor senses and distinguishes between an actual obstacle and wind, even wind gusts, so it doesn't stop unnecessarily, resulting in fewer service calls and end user peace of mind.



Obstacle detection*

Accurately detects obstacles, stopping after meeting an object traveling up or down.

Protects carrier products and prevents fabric damage resulting from screen bunching and slipping from the guides.

Distinguishes between an actual obstacle and wind, even wind gusts, so it doesn't stop unnecessarily, resulting in fewer service calls and end user peace of mind.

Back release

Releases the motor brake after detecting the obstacle preventing fabric damage.

Somfy TaHoma® RTS Smartphone and Tablet Interface

The Somfy TaHoma® gateway and smart phone app provides convenient and customized control of Somfy powered motorized shades, blinds, and other motorized solutions. Control up to 40 RTS (Radio Technology Somfy) channels using the TaHoma app. Multiple TaHoma devices can be joined for multi-zone control.



- North America app, you can remotely activate both Zigbee and RTS products Supports UP/DOWN/MY/STOP commands for motorized shades/blinds .
- Supports incremental control for Tilt motors and lighting ☑ Supports ON/OFF commands for control of lighting or other devices powered via the Zigbee Smart Plug Multiple users .
- Remote access Control4® Certified ☑ Integration with third-party systems over IP ☑ Compatible with Somfy Synergy™ API



TaHoma® RTS



Bond Home / Smartphone and Tablet Interface

Bond Bridge and Bond Bridge Pro works as a bridge between Wi-Fi and your remotes recorded signal allowing you to operate your Sunair shades, awnings, pergolas, ceiling fans, fireplaces and more with the Bond app. Works with Somfy and other motor manufacturers.



Remote control from anywhere

Be able to control everything even from outside your home.



Bond Bridge

- Works with Alexa, Google Home, and SmartThings,
- Remote Control via Bond Home app
- Works with iPhone or Android
- No installation needed
- Smart home functionality without breaking the bank

Bond Bridge Pro: **Added features...**

- Ethernet port & PoE technology
- Smart home integrations
- Ceiling and wall mount

OPTIONAL:

- Sidekick for Shades: 5-channel Shade and awning

BOND REMOTE SWITCH:

Sidekick for Shades/Awnings: 5-channel Shade Keypad



- Wireless flush mount shade remote.
- Communicates directly with the shade.
- 10-year battery life.
- Set up shade limits – no manufacturer remote required.
- This version of Sidekick does not support Scene Keypad functionality.
- 10-year battery life.
- Install with or without a workbox (flush mount).
- 5-channel control.
- Set up shade limits – no manufacturer remote required.



Notes

**Note: Sunair® reserves the right to change engineering, specifications and prices without notice.
Images and Illustrations in the catalog may vary from digital and printed manuals.**

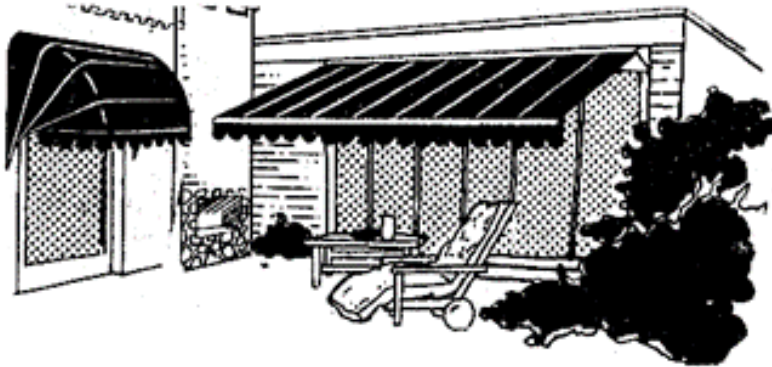

SUNPROOFING AMERICA!



MARYLAND LOCATION

Mailing: P.O. Box 1068
Shipping: 7785 Rt. 175
Jessup, MD 20794

Toll Free 800 - 548 - 0408
Phone: 410 - 799 - 1145
Fax: 410 - 799 - 5584

ARIZONA LOCATION

Mailing: Same as Jessup
Shipping: 3807 West Thomas Rd.
Phoenix, AZ 85017

Toll Free 877 - 272 - 3920
Phone: 602 - 272 - 3920
Fax: 602 - 272 - 3925

www.sunairawnings.com

info@sunairawnings.com