

Architectural Introduction

RETRACTABLE FABRIC ROOF AWNINGS & LOUVERED STRUCTURES



Revised 02/09/2023

Weatherproof Retractable Fabric Roof Systems blocking 100% of UV light
Weatherproof Motorized Adjustable & Retractable Louvered Roof Structures
Integrated Rainwater Management
Engineered for Commercial & Residential Use
Free Standing or Wall Mounted Models
Fabric Roofs In Widths of 42' In a Single Piece Of Fabric
Projections Up To 29'-6"
Larger Systems Can Be Made By Adding Multiple Modules Together
Manual or Motorized with Remote Control & Smart Phone/Tablet Automation
Optional Glass Wall or Roll Down Zipper Screens For More Weather Protection
Integrated Heaters & LED Lighting System With No Exposed Wires



Pergola® Awnings complements both restaurant and residential patio areas. Available in multiple models to best fit your customers' needs and style. Please contact us and we can help you design a system that best fits your client's needs. Pergola® awnings make the patio area usable during the fierce mid-day sun and during rain events. Restaurants will not lose revenue on rainy days and can increase revenue by opening and closing the patio serving area earlier and later in the season when adding roll downs screens and heaters.



Table of Contents

• Introduction to Sunair	Pages	4 - 5
• Available Models	Pages	6 - 10
• What Sunair can provide	Page	11
• Types of Systems & Options	Pages	12 - 23
• Architectural Specifications	Page	24 - 25
• Typical Renderings	Page	26
• Typical CAD Files & Engineering	Page	27 - 28
• Frame and Fabric color options	Pages	29 - 33
• Motors, Controls, & Automation	Pages	34 - 41
• Contacts	Page	42
• Notes	Page	43



The company was originally founded in 1880 in Malmö, Sweden and known as N.P Martensson's Paraply Fabrik (Umbrella Factory), and later became Paraplymårten A.B (Umbrella Marten Inc.). Back then the company manufactured custom sun and rain umbrellas which were sold throughout Sweden and Scandinavia. In the late 1960's the company changed over from umbrellas to the manufacturing of retractable awnings and canopies. The company was very successful in the Swedish and Scandinavian awning market. The company wanted to expand its market. In 1978, the 4th generation Martensson started Sunair® (Awnings Unlimited Inc.) in the USA as a subsidiary to the company in Sweden. Sunair® was the first of modern retractable awning companies to operate in the United States. Subsequently the company in Sweden was sold and the Martensson family focused solely on the U.S operations.

Now the fifth generation operates the company. Sunair® has led the industry since 1978 in creating the highest quality, innovative and custom made retractable awnings and shade systems. In fact, Sunair® was among the first companies to introduce the European style retractable awning to the North American Market and today has two manufacturing plants in North America. With the addition of our Pergola® awnings Sunair is again protecting you from sun and rain as when the it started five generations ago.

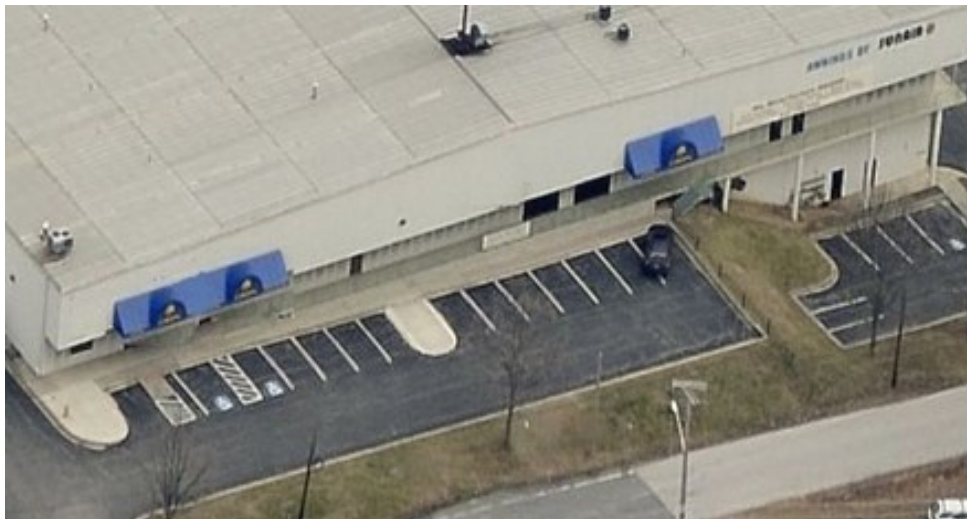

Jessup, MD, near Baltimore



Phoenix, AZ







Today, our product line includes the Pratic Pergola Awning line, Retractable Patio Awnings, Interior and Exterior Rolling Solar Shades, Retractable glass walls and canopies, for homeowners and commercial installations including restaurants. Our products are distributed through our network of independent dealers located throughout North America, Caribbean and Mexico. Our 110,000 square foot North East manufacturing plant and headquarters is located near Baltimore, Maryland. This plant services the entire East Coast and Mid-West. In Jessup is also our main showroom and training facility open to the public and professionals. Our 25,000 square foot Phoenix, Arizona Western manufacturing plant services the entire U.S West Coast direct to the trade from this location. Today Sunair® is a nationally known U.S manufacturer and a successful company, focusing on the fabric shade business. Sunair® specializes in Retractable Awnings, Pergola Awnings, Solar Screens and specialty awning products and now has a national presence with a dealer network throughout the entire US. Sunair® has built a reputation in the industry for a very diverse and high quality product line and over 50 years experience manufacturing exterior shading products.

PERGOLA® AWNING MODELS





	MODEL	Application	Maximum Width	Maximum Projection
	Level Fabric Roof	Wall Mounted Commercial & Residential	5m /16' 5" Type 1 9m / 29' 6" Type 2 13m/42' 7" Type 3	6.5 meters / 21' 4" proj.
	Mito Fabric Roof	Wall Mounted Commercial & Residential	5m /16' 5" Type 1 9m / 29' 6" Type 2 13m/42' 7" Type 3	9.0 meters / 29' 6" proj.
	Tecnic Fabric Roof	Existing structure Mounted Commercial & Residential	5m /16' 5" Type 1 9m / 29' 6" Type 2 13m/42' 7" Type 3	8.0 meters / 26' 3" proj.
	Tecnic One Fabric Roof	Existing structure Mounted Commercial & Residential	5m /16' 5" Type 1 9m / 29' 6" Type 2 13m/42' 7" Type 3	9.0 meters / 29' 6" proj.

MODELS continued

	MODEL	Application	Maximum Width	Maximum Projection
	NOMO Fabric Roof	Free Standing or Wall Mounted Commercial & Residential	5.5 m / 18 ft. wide	7 m / 22' 11" proj.
	RIALTO Fabric Roof	Free Standing or Wall Mounted Commercial & Residential	5.5 m / 18 ft. wide	7 m / 22' 11" proj.
	OPERA Louvered Roof	Louvered Free Standing or Wall Mounted Commercial & Residential	5 m / 5.5 m 16' 5" & 18' wide Depend on config.	7 m / 22' 11" proj. Depend on config.
	VISION Louvered Roof	Louvered Free Standing or Wall Mounted Commercial & Residential	5 m / 5.5 m 16' 5" & 18' wide Depend on config.	6.9 m / 22' 7 5/8 "proj. Depend on config.

Note:
Intermediary
post needed for
OPERA &
VISION above
620 cm Proj.

MODELS continued

	MODEL	Application	Maximum Width	Maximum Projection
	BRERA “P” Louvered Roof	Free Standing or Wall Mounted Commercial & Residential	3.5 / 4.5 m 11’ 5” /14’ 9” Depend on config.	6 / 6.1 m 19’ 8” / 20’ proj. Depend on config.
	BRERA “S” Louvered Roof	Free Standing or Wall Mounted Commercial & Residential	3.5 / 4.5 m 11’ 9” /14’ 9” Depend on config.	3.5 / 4.5 m 11’ 9” /14’ 9” Depend on config.
	BRERA “B” Louvered Roof	Wall Mounted to existing structure Commercial & Residential	3.3 / 4.3 m 10’ 10” / 14’ 1” w Depend on config.	5.85 m / 19’ 1” proj. Depend on config.
	INFINITY	Wall Mounted Commercial & Residential	5m /16’ 5” Type 1 9m / 29’ 6” Type 2 13m/42’ 7” Type 3	7 m / 22’ 11” proj.

MODELS continued

	MODEL	Application	Maximum Width	Maximum Projection
	ALU-TECNIC	Wall Mounted Commercial & Residential	5m /16' 5" Type 1 9m / 29' 6" Type 2 13m/42' 7" Type 3	5.5 m / 18' proj.
	STIL	Wall Mounted Commercial & Residential	5m /16' 5" Type 1 9m / 29' 6" Type 2 13m/42' 7" Type 3	7 m / 22' 11" proj.
	EVO	Wall Mounted Commercial & Residential	5m /16' 5" Type 1 9m / 29' 6" Type 2 13m/42' 7" Type 3	9.0 meters / 29' 6" proj.
	PHOENIX FREE	Free Standing & Wall Mounted Commercial & Residential	5.5 m / 18' wide	6 m / 19' 8" proj.

MODELS continued

MODEL	Application	Maximum Width	Maximum Projection
	<p>Free Standing & Wall Mounted Commercial & Residential</p>	<p>5.5 m / 18' wide</p>	<p>10 m / 32' 9" proj.</p>

Note: All our Pergola model product requires training at the Sunair facility in Jessup, MD. Sunair® may have staff available to help supervise the installation for an additional cost, pending availability at time of installation. For further information please call our Jessup office.



Here is what Sunair can provide you to get your project started

- **“DWG” Drawings** and **“specifications”** for you to specify Pergola awnings into your project.
- Engineering documents for each Pergola model with recommended maximum wind use numbers.
- Provide **fabric and frame color sampling**.
- Provide a local dealer for sales, installation and service.
- Assist dealer & Contractor with **shop drawings** and **signed engineering drawings**.

Please log onto www.sunairawnings.com for further information.

Either click on Pergola Awnings tab, or go to “Architects” section at top of the home page and register.

TYPICAL WALL MOUNTED FABRIC PERGOLA SYSTEMS

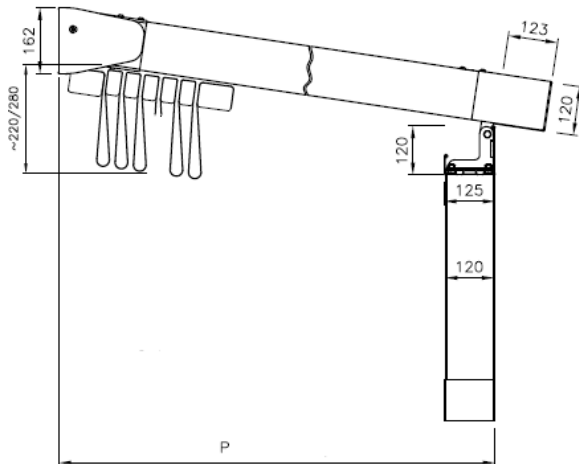
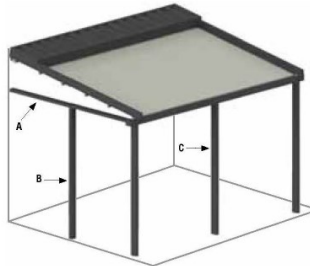
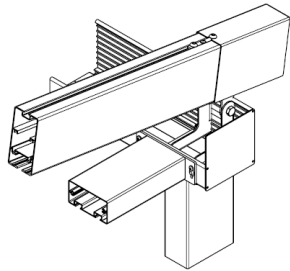
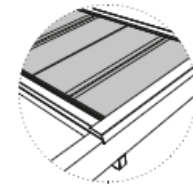
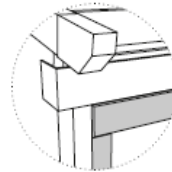
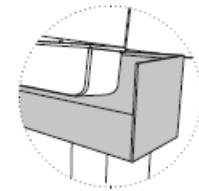
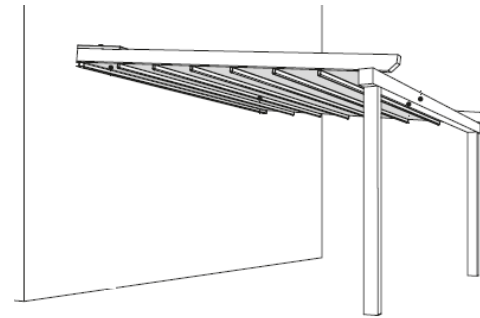
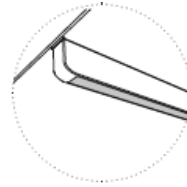
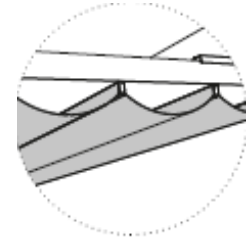
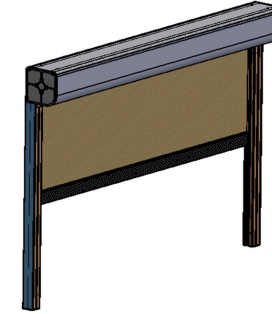

PRODUCT FEATURES:

- Suitable for large & small patio areas.
- Integrated front gutter for water drainage.
- Multiple units can be mounted side by side to create larger width.
- Motorized all sizes and required on larger sizes.
- Optional hood system available.
- Ideal for adding drop down zipper screens.

PRATIC FABRIC PERGOLA® FEATURES AND PATENTS

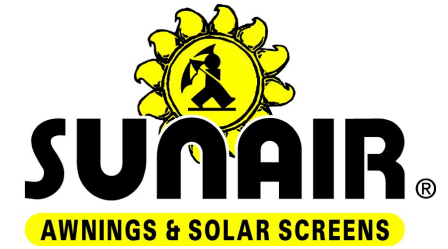
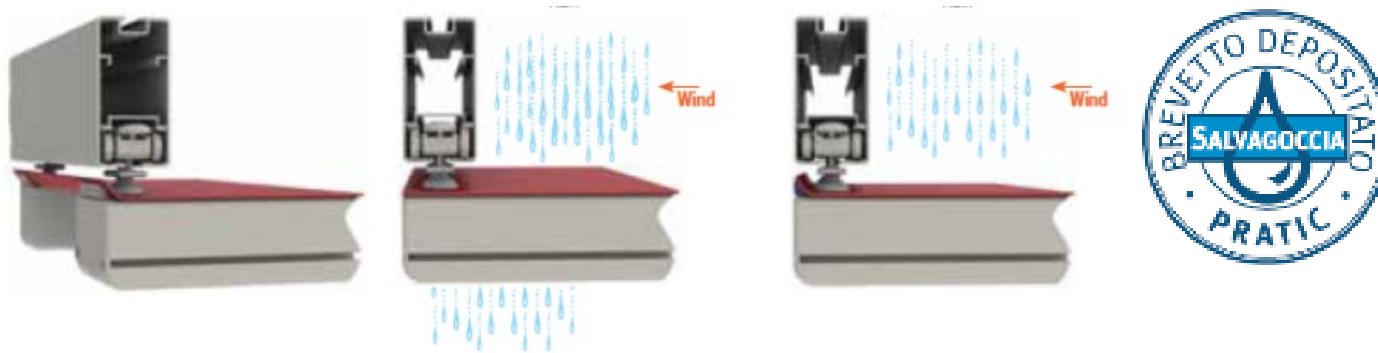

The patented drip catcher keeps water from flowing off the sides when the wind is pushing water sideways. Instead the water will flow off the front or into the gutter.



The patented click system allows for easy and safe installation of the fabric and fabric ribs to the frame carriages using an easy click and lock system.

This patented safety box for the motor installs on the frame with an extra mounting profile. This feature keeps the fabric perfectly straight even in temperature variations. The device makes operating easy and quieter and also stops the motor from operating in case of excessive force. The box is ideally suited for Somfy RTS Altus motors with remote controls.



GENERAL SLOPE & STACK SPECIFICATIONS FOR WALL MOUNTED PERGOLAS

with "Taut" fabric and water drainage to front

See each individual Pergola model for exact requirements

PROJECTION "p"	WIDTHS CM/INCHES Typical Type 1 system												NUMBER OF FABRIC FOLDS	FABRIC VOLUME RETRACTED W/POCKET
	2.5M 8'-2"		3.0M 9'-10"		3.5M 11'-5"		4.0M 13'-1"		4.5M 14'-9"		5.0M 16'-5"			
	CM	INCHES	CM	INCHES	CM	INCHES	CM	INCHES	CM	INCHES	CM	INCHES		
2.0M (6'-6")	44	18	48	19	52	21	54	22	55	22	55	22	3	18"
2.5M (8'-2")	49	20	54	22	59	24	62	25	63	25	63	25	4	19 3/4"
3.0M (9'-10")	54	22	60	24	66	26	69	28	70	28	70	28	5	21 3/4"
3.5M (11'-5")	59	24	66	26	73	29	76	30	78	31	78	31	6	23 1/2"
4.0M (13'-1")	63	25	71	28	79	32	83	33	85	34	85	34	7	25 1/4"
4.5M (14'-9")	68	27	77	31	86	34	91	36	93	37	93	37	8	27 1/8"
5.0M (16'-5")	73	29	83	33	93	37	98	39	100	40	100	40	9	29 1/8"
5.5M (18')	78	31	89	36	100	40	105	42	108	43	108	43	10	30 3/4"
6.0M (19'-8")	82	33	94	38	106	42	112	45	115	46	115	46	11	32 3/4"
6.5M (21'-4")	87	35	100	40	113	45	120	48	123	49	123	49	12	34 3/4"
7.0M (22'-11")	92	37	105	42	119	47	128	51	131	52	131	52	13	36 3/4"
7.5M (24'-7")	97	39	112	45	126	50	136	54	139	55	139	55	14	38 1/4"
8.0M (26'-2")	101	40	118	47	133	53	144	57	147	58	147	58	15	40 1/8"
8.5M (27'-11")	106	42	123	49	139	55	151	60	154	61	154	61	16	42 1/8"
9.0M (29'-6")	110	44	129	51	146	58	159	63	162	64	162	64	17	44 1/8"

THE RECOMMENDED HEIGHT "C" AT THE FRONT BAR IS 230CM OR 90.5"

THE MINIMUM SLOPE "A" FOR WATER DRAINAGE CAN BE FOUND ABOVE IN CHART BOTH IN CM AND INCHES

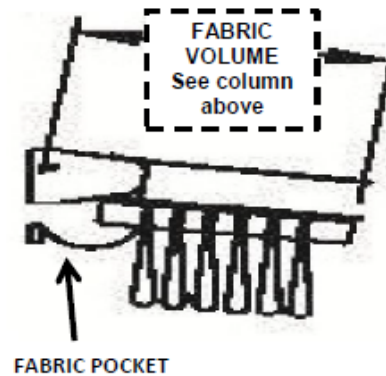
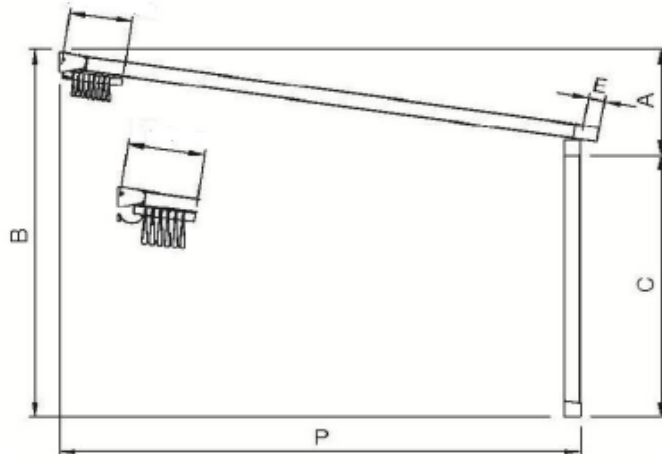

NOMO & RALTO RETRACTABLE FABRIC ROOF PERGOLA

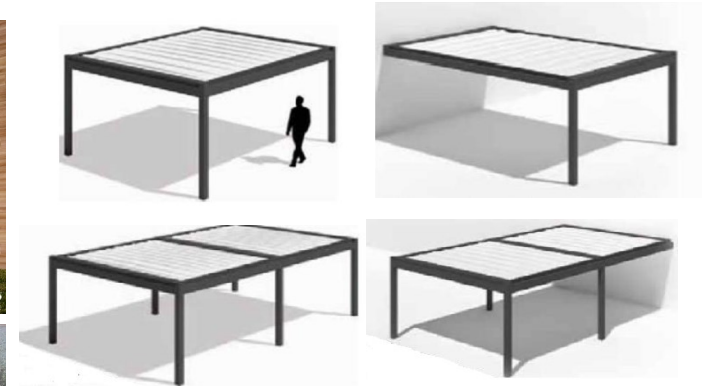

PRODUCT FEATURES:

- Ideal for free standing or wall mounted applications or where flat installations are required.
- Integrated gutter and downspouts for water drainage. Optional screens and RGB LED.
- Arched fabric for better water management with “tilting” Interior gutter.
- Multiple modules can be mounted side by side with common posts to create larger width.



NOMO & RIALTO ADVANTAGES

The rounded arched fabric allows for a compact structure design. The supporting profile and guides are 12 1/2" high (32 cm).

Tilting gutter is a Patented managing water discharge within the structure. Optional telescoping post feet are available for ease of installation.

For greater perimeter protection, the NOMO model can be configured with retractable RASO zipper screens within the structural elements.



The NOMO & RIALTO offers more pre-assembled structure components for a safer and easier installation on site.

The NOMO & RIALTO RGB LED multi colored lighting offers a fascinating elegant remote controlled lighting option (White lights included).

NOMO & RIALTO is a solid made to measure structure that can reach large sizes (18' x 22' 11"). Coupling of multiple structures is possible with minimal intermediate posts.

NOMO & RIALTO: Options

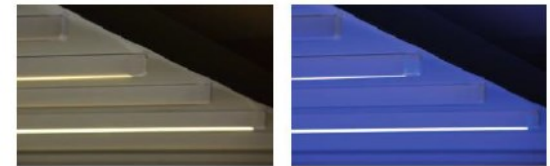

PERIMETER & RIB LED LIGHTING

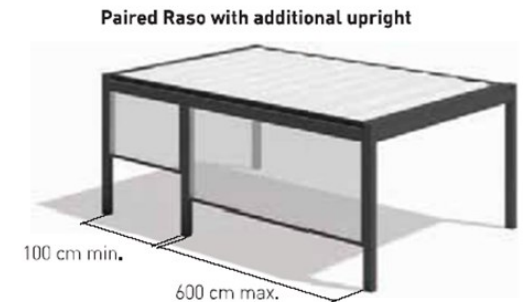
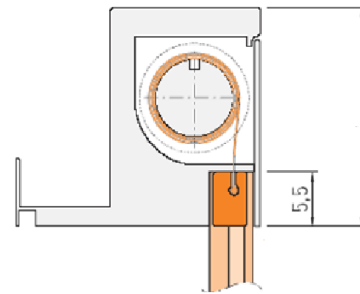

SCREENS

RASO SCREEN: The NOMO model can be fitted with roll down RASO zipper screens for extra weather or sun protection on all sides. This optional screen system can be ordered with either mesh fabric, acrylic or vinyl fabric and clear "film" windows for keeping moderate weather at bay during the winter months or rain during spring and summer months.

OPERA & VISION: ADJUSTABLE LOUVERED ROOF PERGOLA



OPERA & VISION ADVANTAGES

Blades Closed



Blades opened 45 degrees



Blades opened 90 degrees



Blades opened 140 degrees



Blades opened on side



Solar Modulation



Air Recirculation



Rain Protection



Load Resistance



Opera and Vision have been tested to see how waterproof they are by the Giordano Institute which simulated rain equal to 369 mm / hour with pressure of 3.4 bars during an unidentified amount of time. An Opera 14' 9" wide s 19' 8" projection (450 cm wide x 600 cm projection) with two rain events or downpours.

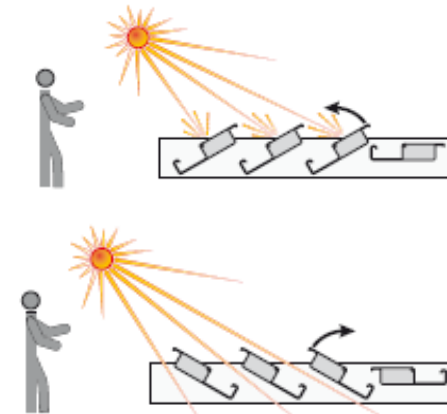

ADVANTAGES con't

The OPERA & VISION can be wall mounted or free standing structures. The supporting profile and guides are 8 1/2" high (22 cm). Posts are 15 cm x 15 cm (Foot plate is wider).

Water management within the gutter system and discharge within the posts. Optional telescoping post feet are available for ease of installation.

For greater perimeter protection, the OPERA model can be configured with optional retractable RASO zipper screens integrated and hidden within the beam system.

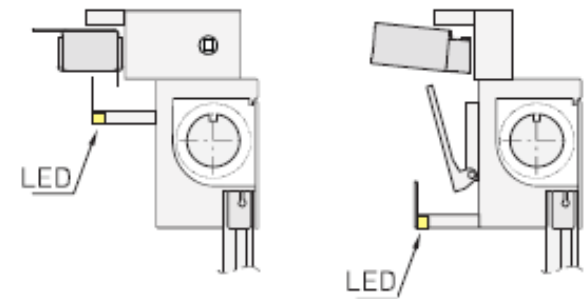

Optional Comfort louvered blades or foam filled louvers minimizing noise from "rain"

The OPERA & VISION offer more pre-assembled structure components for a safer and easier installation on site.

The OPERA & VISION RGB LED multi colored lighting offers a fascinating elegant remote controlled lighting option (White lights included).

OPERA & VISION is a solid, made to measure structure that can reach large sizes (16'5" x 22'11" for Opera model). Coupling of multiple structures to make larger sizes is possible with common posts .

WATER TEST



Opera, Vision, have been tested to see how waterproof they are by the Giordano Institute. They tested for water tightness (blades, gutters and drainage) using the test system certified by the Giordano Institute (Test report no. 319934).

Live LOADS

The tests were conducted and certified by:



DESCRIPTION OF TEST

The test was performed on an Opera bioclimatic pergola measuring 450 cm x 600 cm and on a Nomo bioclimatic pergola measuring 550 cm x 700 cm, professionally installed, simulating precipitation equal to 369 mm per hour and at 3.4 bars pressure, three times the reference value of 100 mm per hour (corresponding to a artificial cloudburst) as required by standard IEC 60721-2-2.

Particular weather conditions and/or particular types of installation can create unforeseeable operating conditions and/or in any case different from the laboratory tests we have carried out and/or can cause water seals, static seals etc. different and/or inferior comparing to the simulations carried out in the laboratory.

RESULT

«No water infiltration inside. Correct drainage with no accumulation.».

Opera, Vision, have been tested to allow for some “live” loads when in use. Please refer Pratic documents calculating maximum permissible live loads for each system by size. Special care must be taken when using the Louvered system in areas where snow falls.

OPERA, VISION, and Brera: Options



PERIMETER & SPOT LED LIGHTING

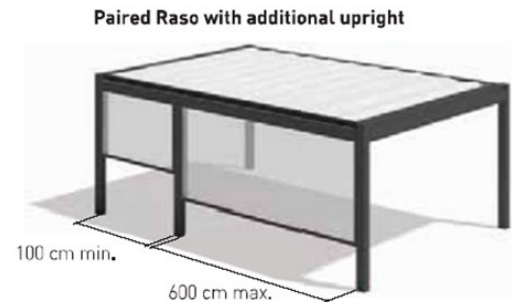
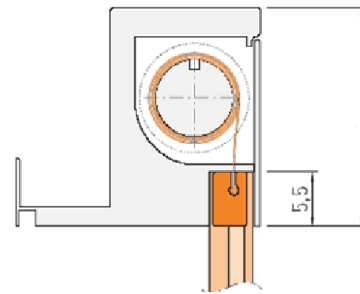

SCREENS

RASO SCREEN: The OPERA, Brera P model can be fitted with roll down RASO zipper screens for extra weather or sun protection on all sides. This optional screen system can be ordered with either mesh fabric, acrylic or vinyl fabric and clear "film" windows for keeping moderate weather at bay during the winter months or rain during spring and summer months.

BRERA: ADJUSTABLE & RETRACTABLE LOUVERED ROOF

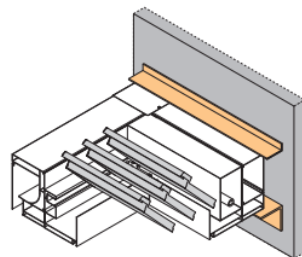
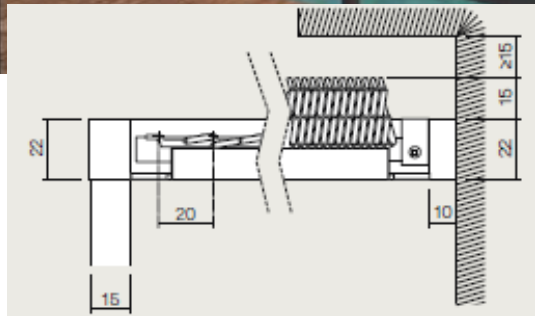
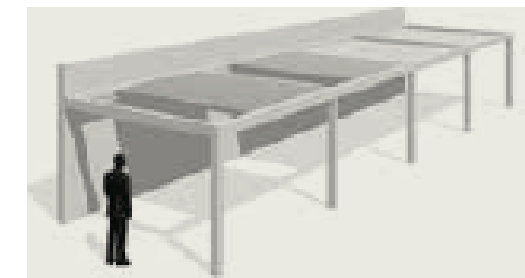
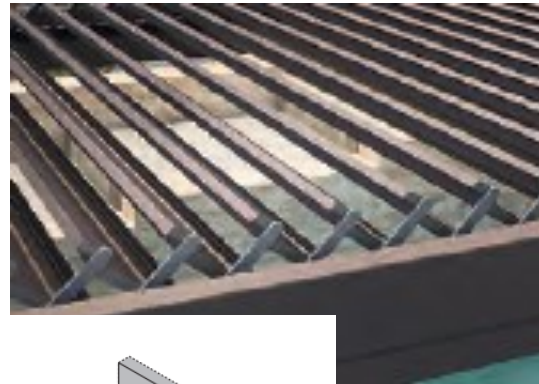
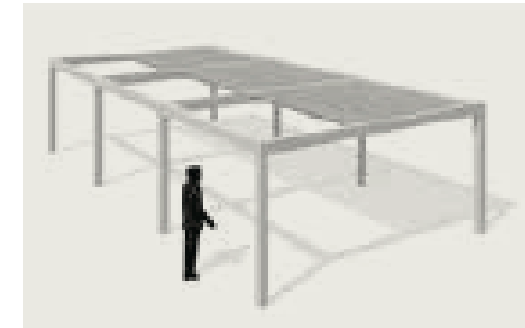
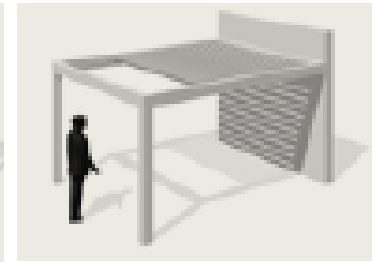
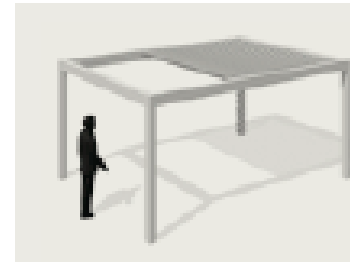

Sunair provides specifications for all our products including the Fabric Pergola roof awnings and Louvered systems. For specifications please go to www.sunairawnings.com and click on the “architects “ section.

Once you register you will be able to download the model “specifications” needed. You will also find architectural and engineering drawings in this section

SECTION SPECIFICATIONS 107313

Retractable Fabric Roof Pergola Awnings
Patio Covers and Pergola Awnings Section 107313 (Old 10530)



**Specs are also
available here**



SUNAIR AWNINGS & SOLAR SCREENS
P.O. Box 1068 7785 Rt. 175,
Jessup, MD 20794

JESSUP, MD 800 – 548 – 0408
PHOENIX, AZ 877 – 272 - 3920

Specifications for Fabric Roof Pergola Awnings by SUNAIR®:

PART 1 - GENERAL

1.1 RELATED SECTIONS:

- A. 107113 Exterior Sun Control Devices
- B. 107300 Protective Covers
- C. 133133 Framed Fabric Structures
- D. 107316 Canopies
- E. 133100 Fabric Structures
- F. 133400 Retractable Engineered Structures

1.2 RELATED DOCUMENTS

- A. Drawings and general provisions of the contract
- B. Fabricated engineered Structure / aluminum frame
- C. Motorized retractable covering system / motors and controls
- D. Fabric
- E. Accessories

Here is what Sunair can provide you to get your project started

- “DWG” Drawings and “specifications” for you to specify our Pergola awnings into your project.
- Engineer available to engage with you to verify and or design the system per local codes.
- Provide fabric and frame color sampling.
- Provide a local dealer for sales, installation and service.
- Assistance with your shop drawing and engineering drawings .

Please email us at info@sunairawnings.com or go to www.sunairawnings.com for further information. Either click on Pergola Awnings tab, or go to “Architects” section at top of the home page and register. If you can not locate what you need, please contact us.

RENDERINGS OF YOUR PROJECT:

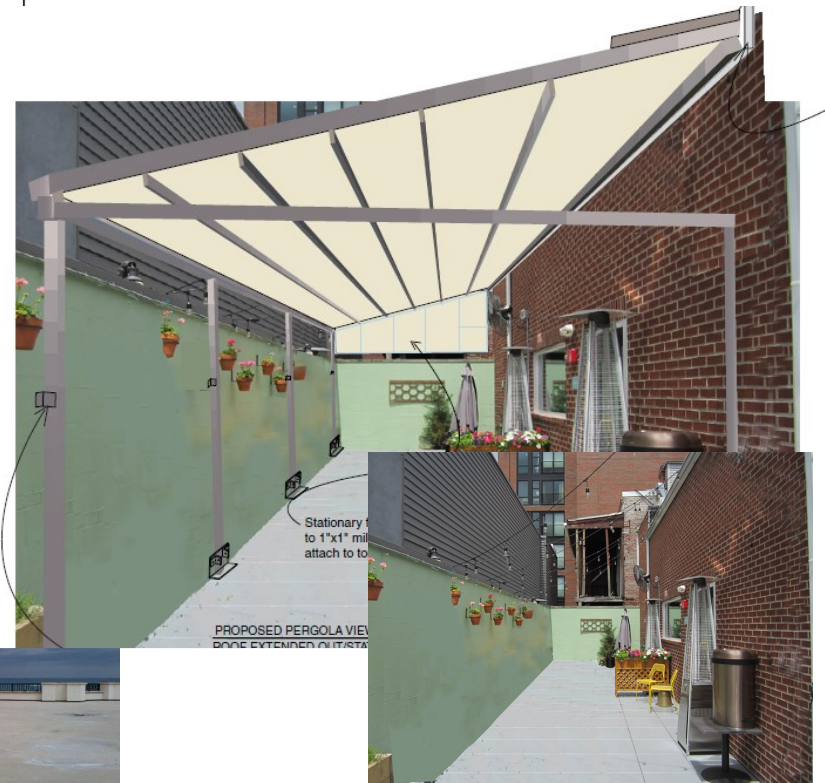
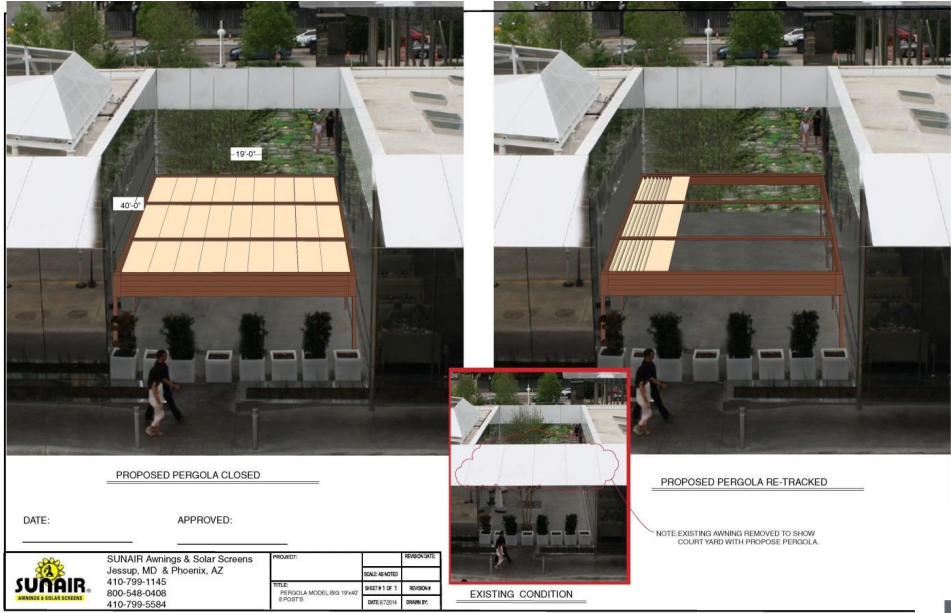

TECHNICAL DRAWINGS:

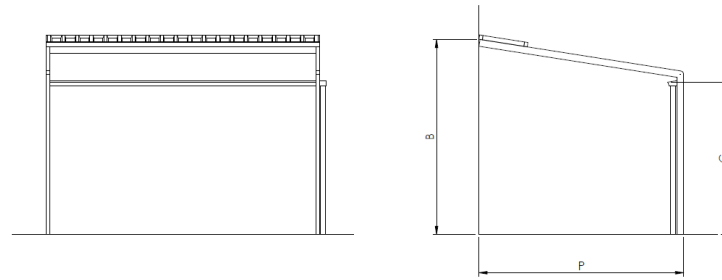
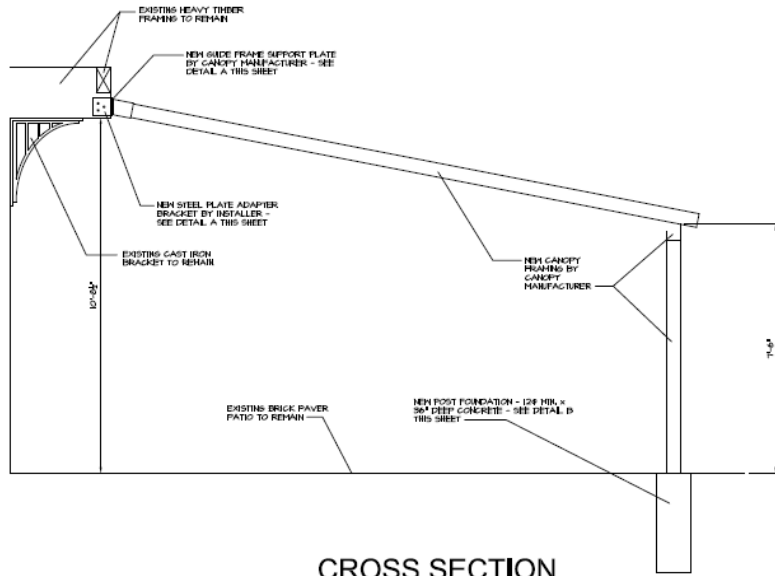

Sunair will provide DWG drawings.

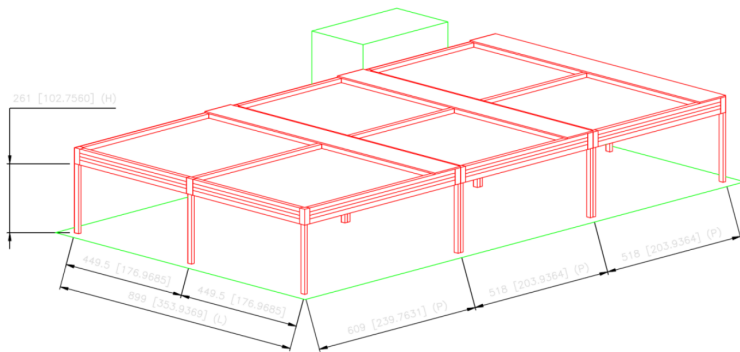
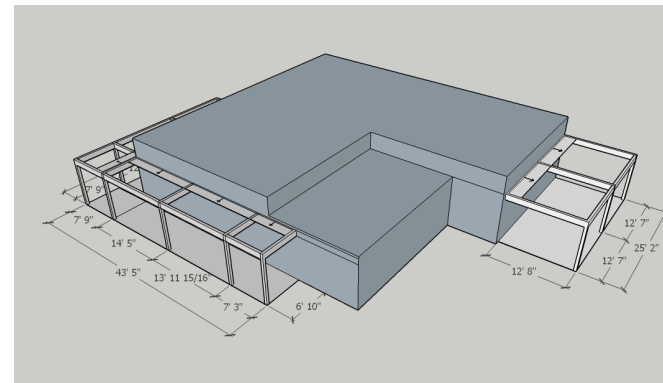
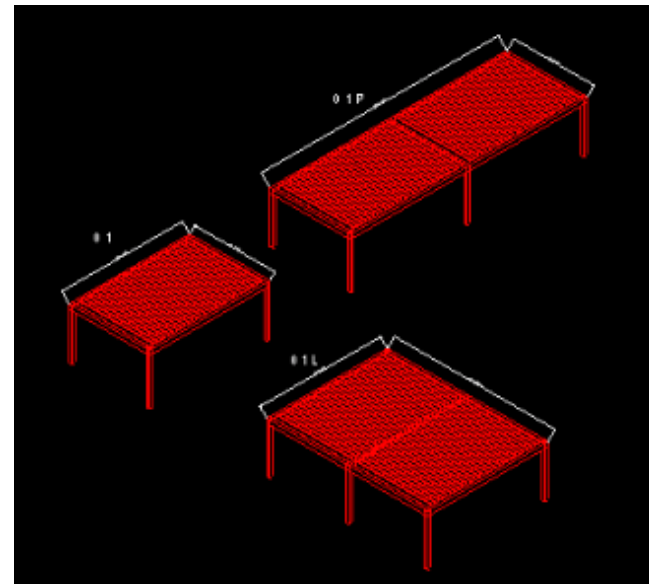

ENGINEERING OF YOUR PROJECT:

Part of the process in engineering the Pergola Awning project and prior to determining final project cost, you will need to evaluate where the Pergola awning is being installed. In all commercial projects and most residential projects a permit is required. In most cases complete site specific engineering of the system is required for permitting and often these engineering drawings will need to be signed by an engineer. If the Pergola is being installed on a multi-story structure, near the ocean, or in an areas of the country or islands subject to heavy winds or heavy storm events you will need to take extra caution in designing the system. Sunair and Pratic has basic engineering calculations available for your use in determining the best awning configuration for your project to see if it meets local conditions and local codes. These calculations are also accompanied by published wind files. If these wind files that Pratic publishes does not meet code or your wind resistance needs, Pratic engineering can review the sizes of the units, and possibly reconfigure the modules in addition to offering re-enforcements options to the structure and installation. If additional engineering calculations have to be made, there will be a fee for that.

Feel free to contact our sales department and we will be happy to assist you at 800-548-0408 or send an email to info@sunairawnings.com

STANDARD FRAME COLORS FOR ALL PERGOLA MODELS:

NOTE: Optional for OPERA, BRERA, & VISION is to have Structure and louvers in two different colors.

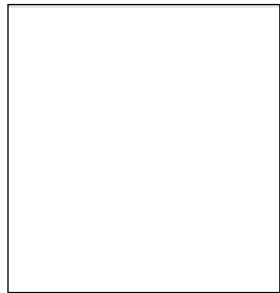

WHITE Gloss
Ral 9010

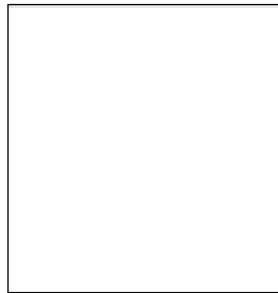

WHITE SAND
Coarse Ral 9016



IVORY SAND
Ral 1013 Coarse

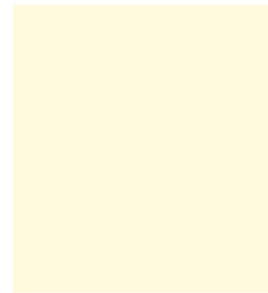

IVORY / SEMI
Gloss Ral 1013



GREY SAND
Gloss Ral 9006



BRIGHT ALUM
Matt Ral 9006

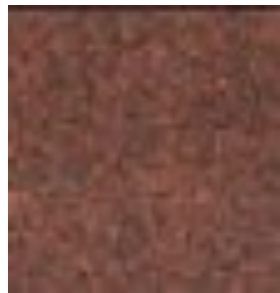

CORTEN
Coarse



IRON GREY
Coarse

OPTIONAL

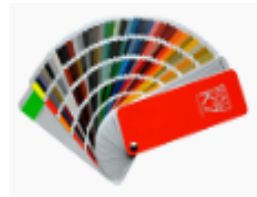

FULL RAL COLOR
RANGE / EXTRA
COST



NOTE: All these colors are “super durables” which offer better durability compared with standard polyesters powders.

NOTE: ACTUAL FRAME COLOR MAY VARY FROM DIGITAL IMAGES

OPTIONAL FRAME COLORS FOR THESE PERGOLA MODELS:

Level, Mito, Tecnic & Tecnic One

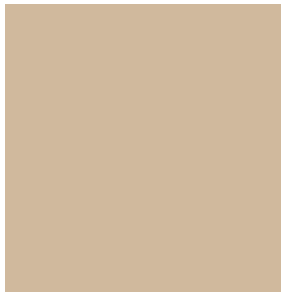

MOCHA
Semi Gloss

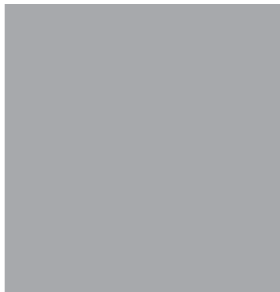

GREY Gloss
Ral 7040

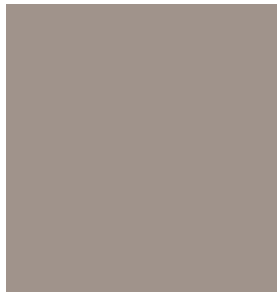

TAUPE Gloss

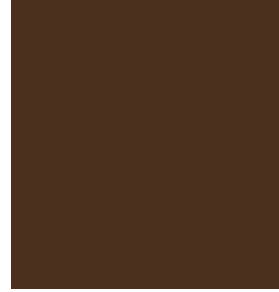

BROWN Gloss



BRONZE
Coarse



BLACK Gloss
Ral 9005

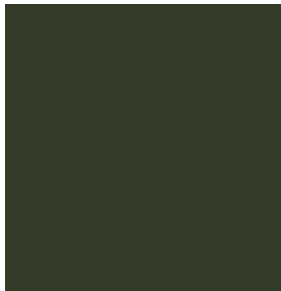

GREEN Gloss
Ral 6005

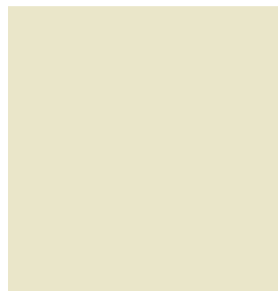

**DESERT SAND /
IVORY Gloss**

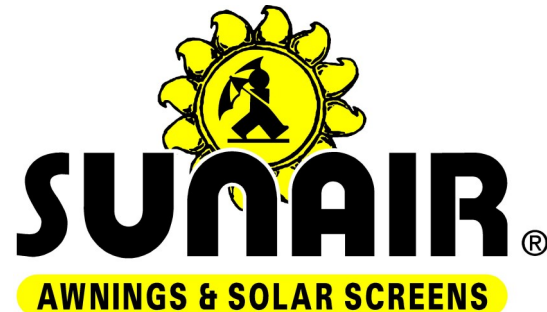

NOTE: All these colors except Green Ral 6005 and Desert Sand / Ivory are “super durables” which offer better durability compared with standard polyesters powders.

NOTE: ACTUAL FRAME COLOR MAY VARY FROM DIGITAL IMAGES

FABRIC ROOF PERGOLA STANDARD COLORS

602 FLEX LIGHT CLASSIC / OPAQUE COLORS



602N-8503 / 8103



602N-50020

The Preconstraint 602 fabric from Ferrari offers excellent dimensional stability with minimal stretching and exceptional dirt resistance thanks to a PVDF topcoat on both sides. The fabric is therefore perfect for use on retractable Pergola® roof awnings. The fabric is 22.1 oz/sq yard with a Glossy finish. The two standard opaque colors above are the most commonly used and is standard on all Pergola® awnings. The two above colors are opaque and do not allow light to go through the fabric. The 602 is also available standard in the 10 each translucent colors above allowing some light to go though. Fabrics are Fire Retardant and certificate is available.

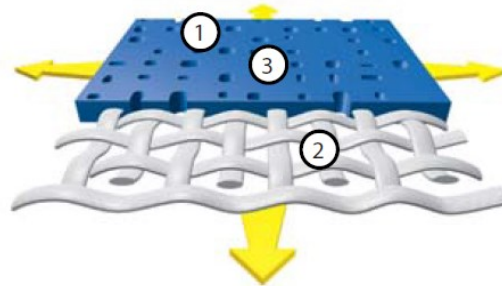

Serge Ferrari

NON STANDARD PERGOLA & SCREEN FABRIC COLORS

502 PROOF SOLTIS / OPAQUE SATIN FINISH COLORS

The Preconstraint 502 fabric from Ferrari also offers excellent dimensional stability with minimal stretching and exceptional dirt resistance thanks to a PVDF topcoat on both sides. The fabric is therefore perfect for use on retractable Pergola® roof awnings. The fabric is 16.8 oz/sq. yard with a satin finish. Fabrics are fire retardant and certificate is available.



satin finish

Serge Ferrari



14 % Open Screen Mesh

Raso Screen Fabric

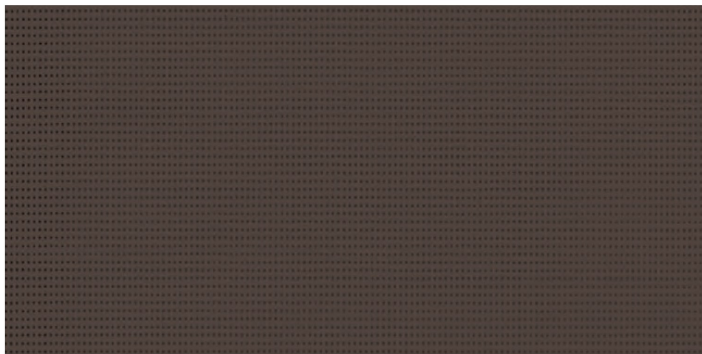

86-2043
Bronze

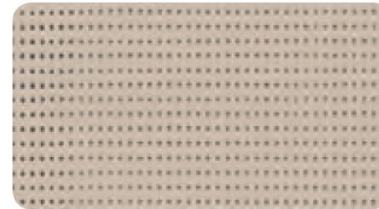

86 – 2135
Sandy Beige

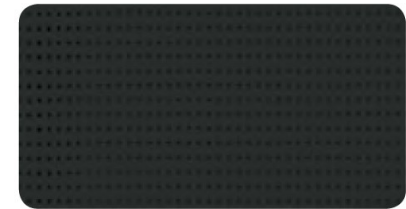

86 – 2053
Black

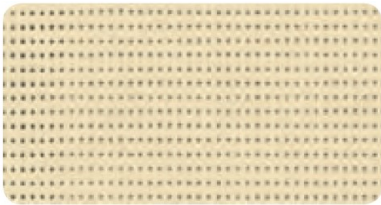

86 – 2175
Champagne

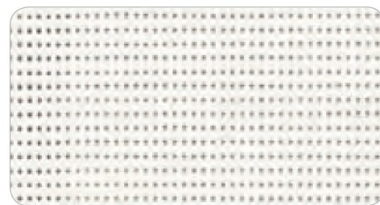

86 – 2044
White

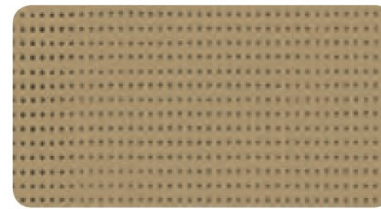

86 – 2012
Pepper

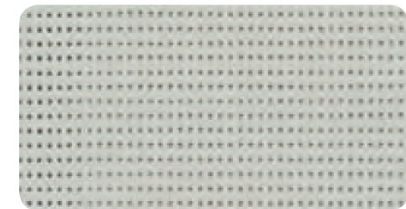

86 – 2171
Boulder

■ **Technical properties**

Openess factor	14%
Weight	380 g/m ² — 11.2 oz/sqyd
Thickness	0.45 mm — 450 microns
Width	177 cm - 267 cm — 69.7 in. - 105.1 in.

Superior elongation and tear resistance

No deformation during processing and use

Superior aesthetic and mechanical durability

Smooth finish easy to clean, space saving, easy rolling

MOTORIZATION & AUTOMATION

ALTUS®



Note:

Opera and Vision Louvered systems uses a different Linak motor and remote.

The Sunair PERGOLA® program features SOMFY RTS motor with an integrated radio receiver that allows you to operate the fabric pergola awnings or screens by remote control with a wall mounted or hand held remote and by a smart phone device.

With a simple click of a button on your remote, the awning or shade will extend, retract , lower or raise automatically.



1 through 16 channel wall mounted and hand held remotes are available



OUR FABRIC ROOF PERGOLA® MOTORS

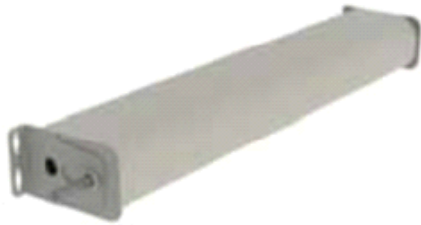

Sunair uses Somfy motors and controls for their Pergola awnings

Altus 525/530 series: Phoenix pergolas

Altus 550 Series: Nomo, Rialto , Brera Louvered, Type 1 & 2 Pergolas

Altus 660 Series: Type 3 Traditional Pergolas

All Somfy Motors are UL and CSA Recognized

- All SOMFY motors are UL Recognized and can be found under the following file numbers:

E60495, E60888, E63714



	550	660
Torque	50 Nm	60 Nm (530 in. lbs.)
Nominal Voltage		120V / 60Hz
Rated Current	2.1A	2.5A
Speed	14 rpm	14 rpm

Type of power cable

RTS
120V AC / 60Hz
3 conductor cable



white = neutral
black = hot
green = ground



Radio Technology Somfy

Radio Technology Somfy® (RTS) allows wireless radio control of motorized applications via the RTS family of controls.

Screen motor for RASO & SC4500 zipper screens

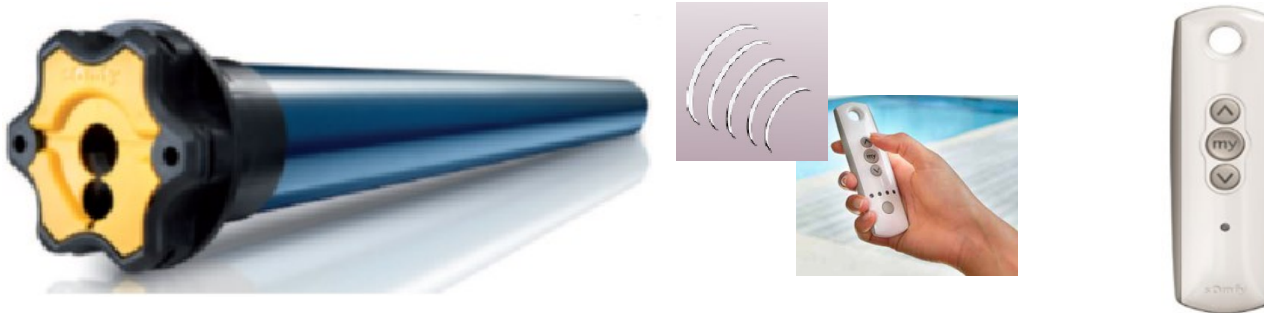

SCREEN MOTORS:

The screens are available with the **525 altus SOMFY** motor and also the **525 Maestria Obstacle detection motor**. These motors are tubular 110 volt motors and are integrated into the Raso roller tube like a normal screen motor. Electrical wiring for the Raso screens is integrated within the gutter system and posts and all electrical connections are pre-wired within the Pergola system to one central connection point for all the electrical options and motors. The Maestria obstacle detection motor prevents fabric damage resulting from screen bunching and slipping from the guides. The motor senses and distinguishes between an actual obstacle and wind, even wind gusts, so it doesn't stop unnecessarily, resulting in fewer service calls and end user peace of mind.

Type of cable

RTS
120 V / 60 Hz
3 conductor cable

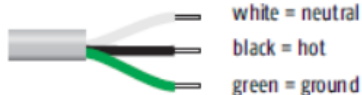

Note: It is recommended to use a multi channel Telis 4 remote to operate multiple screens. The Screen motors use the same RTS motor as all Pergola models except the Louvered Pergola systems. The Louvered OPERA & VISION systems use a separate TELECO remote control to operate the Louvered 24 volt motor and LED's.

Performances

525A2

Torque	25 Nm
Nominal Voltage	
Rated Current	1.6A
Speed	20 rpm
Thermal Protection	
Radio Frequency	433.42 MHz

FABRIC PERGOLA & SCREEN SENSORS



SOLIRIS RTS 24V KIT **Sun & Wind Sensor**

The Soliris RTS Sun and Wind Sensor automatically controls y



ONDEIS® WIREFREE **Sun & Rain Sensor**

The Rain Sensor is a solar-powered combined rain and sun sensor compatible with Radio Technology Somfy® motorized exterior products, including awnings and screens.

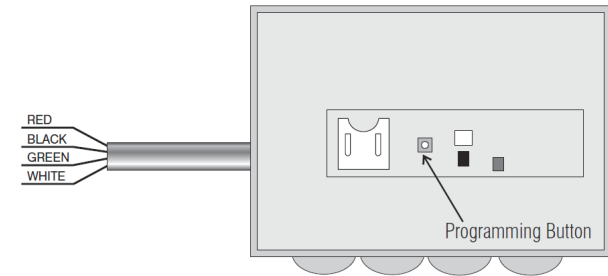

DRY CONTACT INPUT RTS TRANSMITTER

Dry Contact to RTS interface can be used to communicate between home automation or other third party systems like fire alarms to retract screens in an emergency. Can be interfaced with a physical switch.

OPERA & VISION LOUVERED PERGOLA RAIN SENSORS

The Rain Sensor is a low voltage wired sensor that connects directly to the Opera and Vision louvered system and Teleco remote. If rain is detected, the pergola will close and the remote control will be needed to open it back up.



Rain Sensor

Somfy TaHoma® RTS Smartphone and Tablet Interface

The Somfy TaHoma® gateway and smart phone app provides convenient and customized control of Somfy powered motorized shades, blinds, and other motorized solutions. Control up to 40 RTS (Radio Technology Somfy) channels using the TaHoma app. Multiple TaHoma devices can be joined for multi-zone control.



- North America app, you can remotely activate both Zigbee and RTS products Supports UP/DOWN/MY/STOP commands for motorized shades/blinds .
- Supports incremental control for Tilt motors and lighting ☑ Supports ON/OFF commands for control of lighting or other devices powered via the Zigbee Smart Plug Multiple users .
- Remote access Control4® Certified ☑ Integration with third-party systems over IP ☑ Compatible with Somfy Synergy™ API



TaHoma® RTS



Bond Home / Smartphone and Tablet Interface

Bond Bridge and Bond Bridge Pro works as a bridge between Wi-Fi and your remotes recorded signal allowing you to operate your Sunair shades, awnings, pergolas, ceiling fans, fireplaces and more with the Bond app. Works with Somfy and other motor manufacturers.



Remote control from anywhere

Be able to control everything even from outside your home.



Bond Bridge

- Works with Alexa, Google Home, and Smart-Things,
 - Remote Control via Bond Home app
 - Works with iPhone or Android
 - No installation needed
-
- Ethernet port & PoE technology
 - Smart home integrations
 - Ceiling and wall mount

OPTIONAL:

- Sidekick for Shades: 5-channel Shade and awning Keypad

BOND REMOTE SWITCH:

Sidekick for Shades/Awnings: 5-channel Shade Keypad



- Wireless flush mount shade remote.
- Communicates directly with the shade.
- 10-year battery life.
- Set up shade limits – no manufacturer remote required.
- This version of Sidekick does not support Scene Keypad functionality.
- 10-year battery life.
- Install with or without a workbox (flush mount).
- 5-channel control.
- Set up shade limits – no manufacturer remote required.



OPERA & VISION MOTOR

24 VOLT BLADE MOTOR OPERA & VISION / Technical

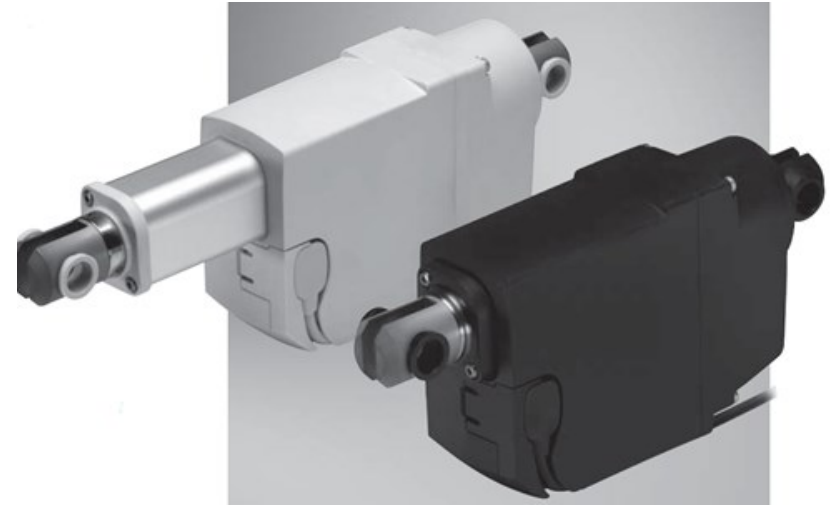

The Linak Actuator Blade motors are 24 volt motors. They operate the Louvered metal blades only for the top roof to rotate the blades back and forth from 0 - 140°. A 150 watt transformer is included with the Opera or Vision unit and is pre-wired inside the Post of the Opera unit. The transformer is pre-wired in the top gutter system of the Vision model. The input for the 150 watt transformers is 230v or 110v and with either 50Hz or 60 Hz. Each "Module" will have its own 24 volt motor. If multiple Opera or Vision sections are joined together, each unit or module will have its own 24 volt Linak motor. The Louvered Pergola remote is available in multi-channel to accommodate multiple Linak motors as well as also controlling the LED strips and lighting. Any optional "Raso" roll down screens configured with your Opera unit will use a 110 volt Somfy Altus motor and will be wired separately from the Linak 24 volt motor. The Somfy motor does not utilize a transformer and has its own Telis Somfy remote. The Linak "blade" motors will have its own remote controller and any roll down screens will have its own remote controller. Up to two (2) Linak Blade motors can be wired on each 150 watt transformer. Four (4) Louvered modules will be wired with two – four transformers.

CONTACTS

SUNAIR® AWNINGS & SOLAR SCREENS

P.O Box 1068 Jessup, MD 20794

Phone: 410-799-1145 1-800-548-0408 Fax: 410-799-5584
www.sunairawnings.com info@sunairawnings.com

Sales department: 800-548-0408

sales@sunairawnings.com

Sunair Pergola Partners:

pratic



Serge Ferrari



NOTES:

Note: Sunair® reserves the right to change engineering, specifications and prices without notice. Images and Illustrations in the catalog may vary from digital and printed manuals. Sunair® is not responsible for printed inaccuracies in this manual.

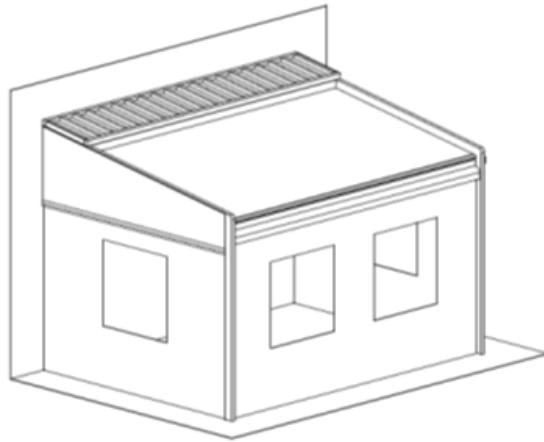

SUNPROOFING AMERICA!



MARYLAND LOCATION

Mailing: P.O. Box 1068
Shipping: 7785 Rt. 175
Jessup, MD 20794

Toll Free 800 - 548 - 0408
Phone: 410 - 799 - 1145
Fax: 410 - 799 - 5584

ARIZONA LOCATION

Mailing: Same as Jessup
Shipping: 3807 West Thomas Rd.
Phoenix, AZ 85017

Toll Free 877 - 272 - 3920
Phone: 602 - 272 - 3920
Fax: 602 - 272 - 3925

www.sunairawnings.com

info@sunairawnings.com