



SUNTUBE® Retractable patio awning

The Suntube® awning system is the ultimate state of the art retractable patio awning system. The Suntube® enjoys the many of the same quality components as on our popular Sunair® model. The fabric of the Suntube® is entirely protected by a tubular hood system when the awning is retracted. The tube is extremely attractive styling with a designer styled end cap for a finished look.

Type	Standard Frame Colors	Standard Widths	Standard Projections	Recommended Applications	Recommended Fabrics
Lateral Arm Awning	9 standard Sunair colors	Through 20'	4'2", 5'7" 6'11", 8'7", 10'2", 11'6", 13'0",	Deck, Patio & Storefront Roof mounts	Sunbrella, Tempotest / Para, Sattler, & Recasens



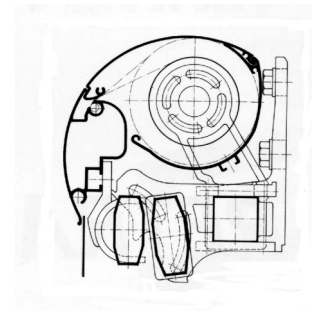

- Tubular aluminum hood design protecting the fabric.
- Highest quality Lateral Arm Awning.
- Forged aluminum elbow and shoulder components.
- Double stainless PVC coated cable arm design for durability.
- 4:1 / 8:1 Bevel gear for most efficient operation.
- All aluminum extruded front bar, Torsion bar, and roller tube.
- Powder coated components and extrusions.
- A stop in the gear to prevent the fabric from over rolling.
- Stainless steel fasteners.

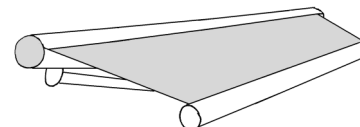



9"

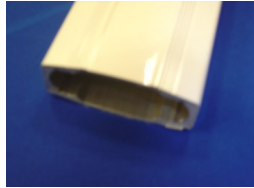

Revised 02/15/2023

<u>SUNTUBE® MODEL FEATURES:</u>		<u>COMPETITION</u>	<u>SUNTUBE® BENEFIT:</u>
ARMS	 <p>All arm parts under stress are made of forged aluminum including the shoulder, elbow, and arm components. All arms 8' 7" and above use three heavy duty steel springs.</p>	Others typically uses all Die-cast or extruded aluminum arm parts and one or two springs to save on cost.	Forged aluminum arm components are stronger than all die castings or extrusions resulting in a stronger awning against the elements. Three heavy duty steel springs provide better arm tension and longer arm life.
TUBULAR HOOD	 <p>The Suntube® is unique in the fact that it has a built in hood that protects the awning fabric when the awning is retracted.</p>	Most systems including our other two systems use an optional aluminum hood sometimes made of fabric.	The tube truly protects the fabric when the awning is in retracted position. The tube also has a finished look second to none.
ELBOW	 <p>The Suntube® uses twin high quality stainless aircraft cable covered in a vinyl PVC sleeve.</p> <p>The hinge is triple angled with an elliptical cable radius.</p>	Typically the competition uses a single smaller cable which is not always coated. Most systems do not have this angle and the fabric rubs on the arms.	Twin covered cables are far superior to a single cable, as cable wear is reduced, allowing better arm and fabric tension and durability. The elliptical cable radius increases tension as the awning extends. The angles help keep the fabric from dragging on the arms.
GEARS	 <p>Suntube® uses a heavy duty German 4:1 ratio bevel gear with a stop.</p>	The competition often uses inferior quality 7:1 gears without a stop	The 4:1 gear is the most efficient gear made. This gear minimizes the time and effort needed in operating a manual awning. The stop eliminates fabric damage due to over rolling.

<u>SUNTUBE® MODEL FEATURES cont.</u>		<u>COMPETITION</u>	<u>SUNTUBE® BENEFIT:</u>
PROFILES & PAINT		All extrusions and components are exclusively made of the highest quality aluminum. The extrusions and aluminum parts all electro statically powder coated.	The competition often mixes aluminum and steel profiles to save on cost. Competitors very often actually wet – lacquer the extrusions to save on cost. Aluminum extrusions are strong, yet will not corrode over time like steel. This equates to a longer lasting awning. Powder coating is more attractive and holds up better against the elements, resisting cracking and peeling.
FABRICS		Hundreds of 100% acrylic premium grade solid and striped fabric colors to choose from. You surely will find a fabric to suite your need and taste.	Sometimes the competition uses vinyl or a non acrylic fabric. Some companies use poor quality lighter thickness acrylics fabrics. Acrylic fabric is more attractive and breaths better than vinyl. Vinyl traps heat and will crack over time. Acrylic fiber is also resistant to fading and mildew and has a water repellant Teflon coating.
THREAD		All fabrics are sewn with Tenara® thread. This thread is manufactured from GORE-Tex, and is clear and nearly invisible.	The competition typically uses a synthetic thread. Often the competition cuts corners and uses only a white thread which is very visible on the fabric. Tenara® thread is made of Teflon and will not deteriorate from exposure to the elements. The clear thread is nearly invisible on most fabric colors.

Note: Available features
will vary by model

THE SUNTUBE IS THE CLEAR CHOICE!



SUNTUBE® Cross section

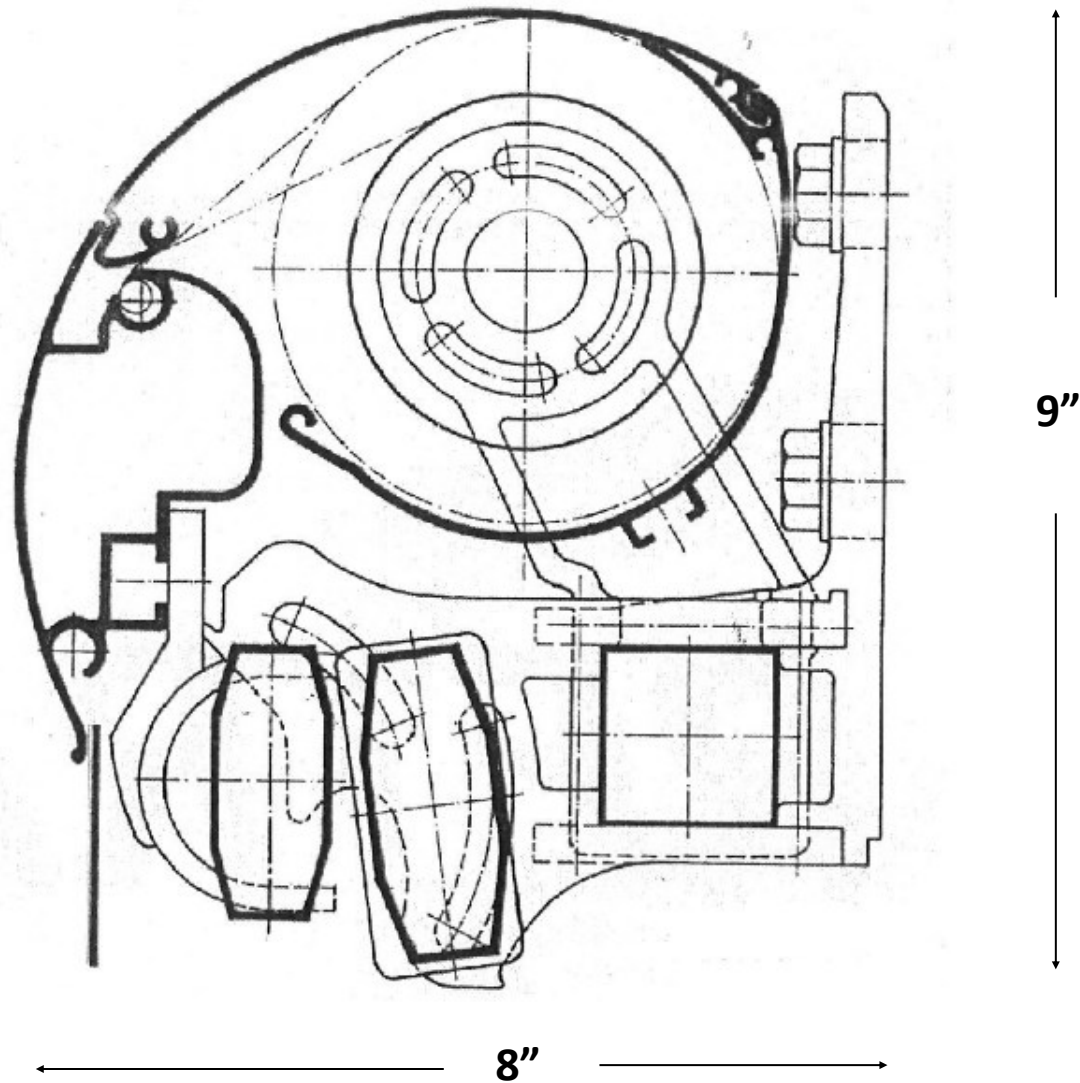

Suntube Installations



Suntube® extended



Suntube® retracted



Suntube® is ideal for roof mounts



Suntube® up close

BENEFITS OF AWNINGS



- Reduces indoor temperatures and energy costs while keeping you cool on your deck or patio.
- Reduce heat gain inside by as much as 77% and reduce sunlight and glare through your window by as much as 94% (see Minnesota energy study).
- A Sunair awning keeps you cool on your patio or deck, but it also minimizes your exposure to the sun's harmful rays.
- A Sunair® retractable awning will increase your outdoor living area comfortably and efficiently at a fraction of the cost of a permanent addition
- Increases the value of your home.

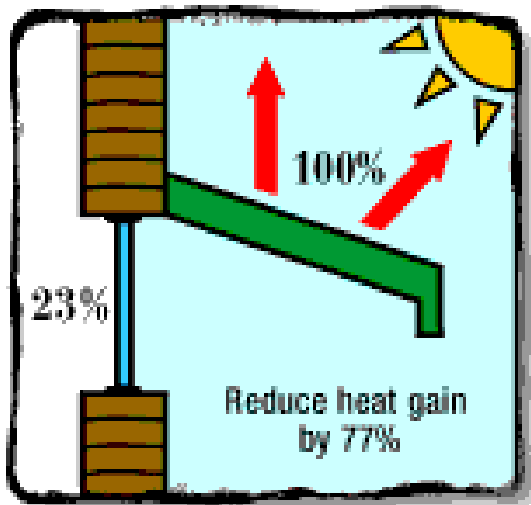

MEASURING A LATERAL ARM AWNING:

WIDTH:

The width is based upon the size of the deck. Due to the large sizes of some decks it is not always necessary to cover the entire deck. Make sure the wall is free of down spouts, chimneys and electrical conduit. Any object protruding out from the wall will interfere with the roller mechanism. Note the hood is always 1" wider than the width of the awning frame. The fabric width is always 5" less than the awning frame on units up to 20' wide, and 5 1/2" less on units over 20' wide. If the deck faces the West, then projection is important to consider. If the deck faces South, then width is important to consider.

The roller assembly of the SUNAIR® measures 8" high without a hood and 10" high with a hood. Be certain that you have at least 8 – 10" of unobstructed mounting surface.

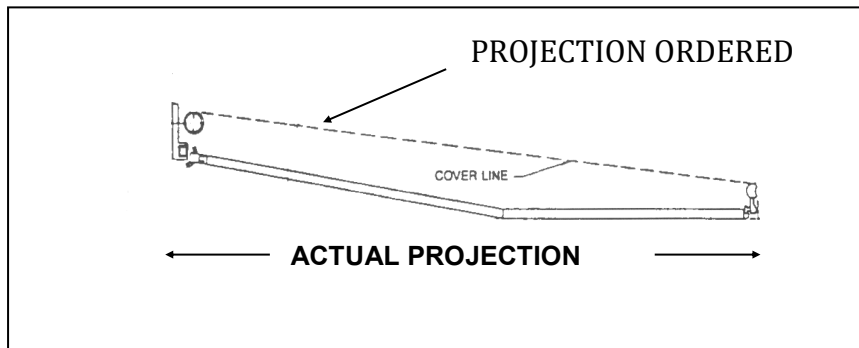
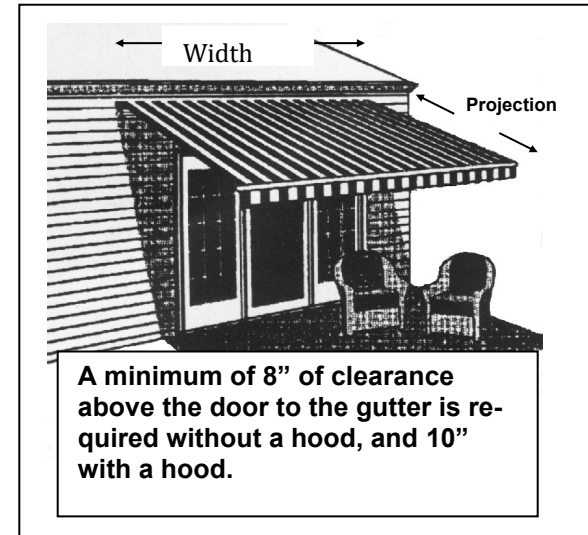

The SUNAIR® Lateral Arm Awning is designed for residential decks, patios and commercial storefronts. Smaller projections should be used for a storefront awning. The awnings are designed for sun protection; they are not designed to withstand wind or heavy rain and should not be sold for such purposes (see warranty).

PROJECTION:

Determine the ground clearance above the door or window and then determine the desired projection. Refer to the pitch chart on next page for the ideal mounting height and pitch for the desired projection. The greater the pitch on the awning the less projection it will have (see pitch chart). When the awning is extended the front bar should be at least 7 ft. off the deck or patio. On a commercial installation the distance from the ground to the front bar should be at least 8 ft. depending on local codes. The pitch chart indicates that for every 12" of projection of the awning the mounting brackets should be located 3" higher than the front bar when the awning is extended (3/12 rule).

PITCH CHART AND IDEAL MOUNTING HEIGHT

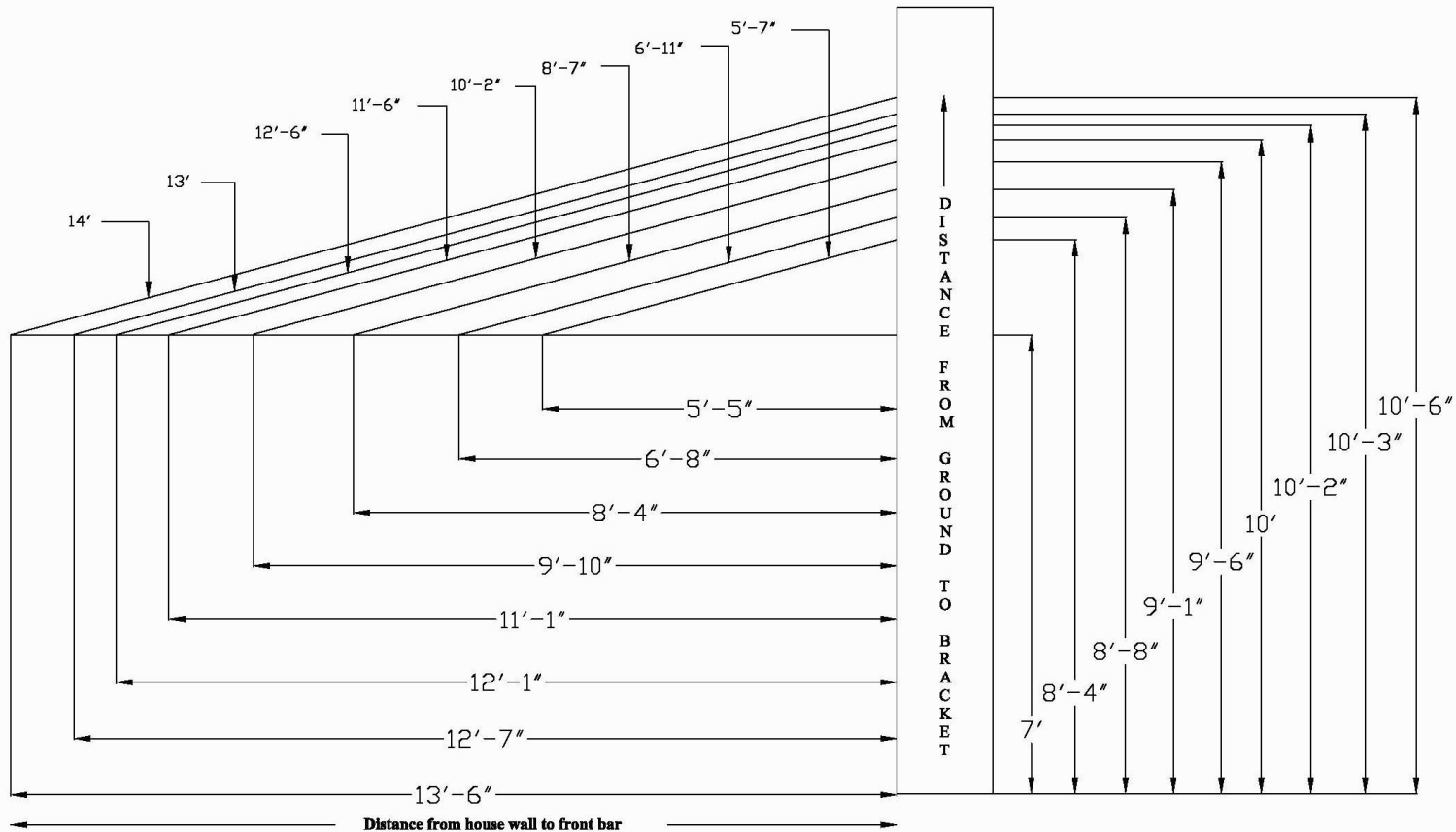

For example: The brackets on an awning with 10' projection needs to be mounted 9'6" from the ground on a residential installation, $10' \times 3'' = 2'6''$ & $2'6'' + 7' = 9'6''$). Because the ideal pitch may not always be attained, it is possible to install the awning lower than the ideal pitch. While the "3/12" rule is ideal, it is perfectly fine to install the awning with a 2/12 pitch. A 1/12 pitch is absolute minimum. Maximum pitch is 45°.

Note: A good rule of thumb is never to install a Lateral Arm Awning below 8 feet at the top of the installation bracket. If only eight feet is attainable do not install an awning with more than 10'2" projection. If the installation height is too low or the desired projection is too great for the available space the awning may have to be installed on the roof (see the installation manual for each individual model).

OPTIONAL LED KITS FOR YOUR LATERAL ARM AWNING

SOMFY LIGHT KITS



- Available in warm white and cool white colors.
- Kits available for arms on awning system.
- Compatible with the Sunea SOMFY manual override motor only.
- Uses a Dimmable remote lighting kit.
- Use a multi channel remote.
- Lights installed in the field by dealer.

SUNAIR LIGHT KITS



5MM ILUMA™ LIGHT STRIPS

- Available in warm white color.
- Kits available for arms and front bar .
- Compatible with the Sunea SOMFY manual override motor and can be used with other motor systems as well.
- Uses a Dimmable remote lighting kit.
- Use a multi channel remote.
- Lights installed at the Sunair factory during assembly.

AU41 AWNING ASSIST BRACES

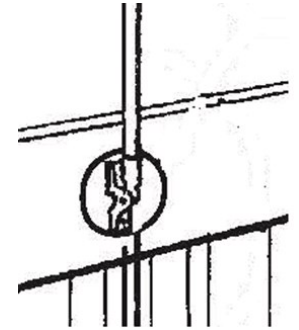
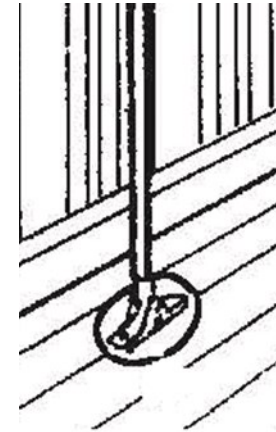
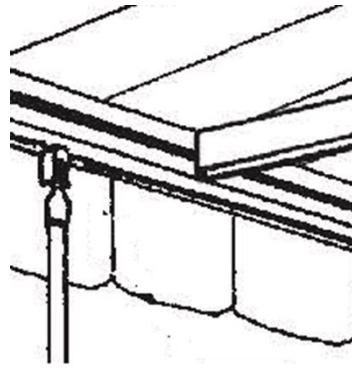
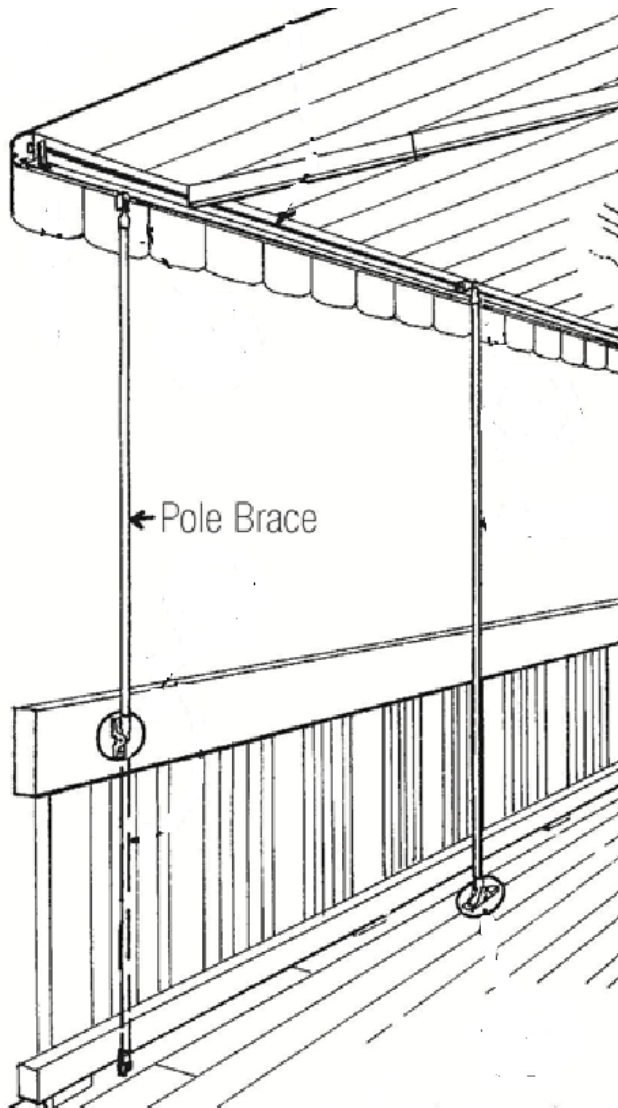

8 ft. Long

Minimum 2 posts needed per awning.

One (1) post per arm needed.

If 3 arms, 3 posts needed.

For Sunair®, Sunstar®, and Sunchoice® models only (Not for Suntube® model).

Must be released before operating awning.

AU41 Available Colors:

White, Mocha, Ivory, Black

Note: colors may not match exactly with awning frame.

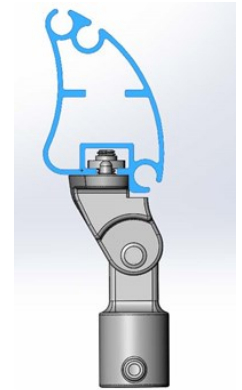

Sunair® Front

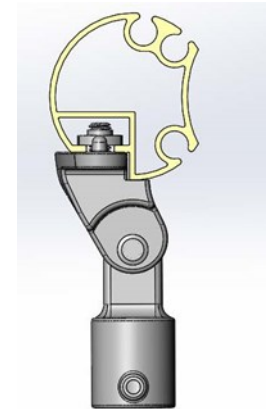

Sunstar® Front

ASSIST BRACES cont.

Typical Installation of the manually operable pole brace to a typical existing awning canopy

- A1 Top end of pole brace secured to bottom slot channel of existing front linear aluminum extruded channel.
- A2 Lower end secured to a existing rail or wall.
- B1 Top end of pole brace secured to rear slot channel of existing canopy front linear aluminum extruded channel.
- B2 Lower end secured to a existing ground building surface.
- C During the partial projection of a existing awning canopy the lower end of pole brace may be secured to ground surface or side rail or wall.

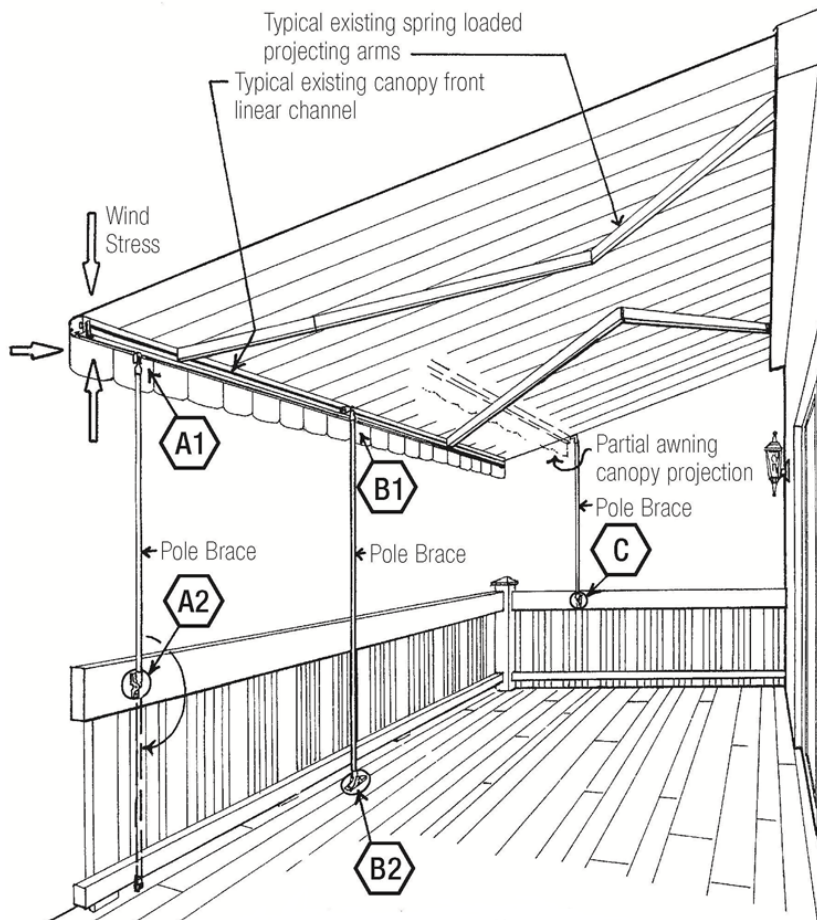

8 ft. posts can be cut down to desired length.

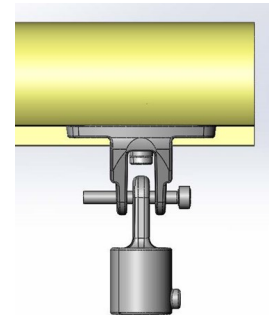

NOTE: The Assist braces provide added stability to a retractable awning when it is extended. Adding these posts does not make the awning into a stationary awning. There is also no guarantee the awning will not be damaged in wind. Damage to awning or property is NOT covered by the Sunair® warranty. Please see warranty and separate instructions for proper use of these posts.

FRAME COLORS (STANDARD)

Awnings *

*Note: See each model technical page for available frame colors. Available interior screen colors are different than depicted below (see Interior screens).

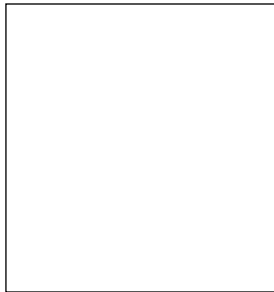

WHITE Gloss
Ral 9010

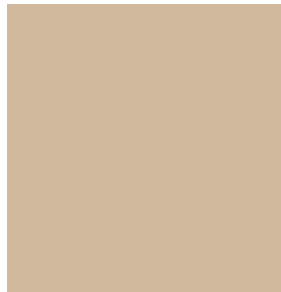

MOCHA
Semi Gloss

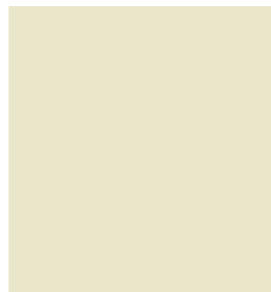

**DESERT SAND /
IVORY Gloss**



BLACK Gloss
Ral 9005



BRONZE
Coarse



GREY Gloss
Ral 7040

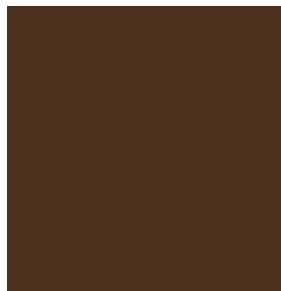

BROWN Gloss

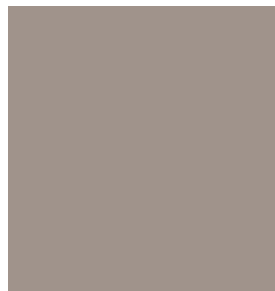

TAUPE Gloss



GREEN Gloss
Ral 6005

OPTIONAL

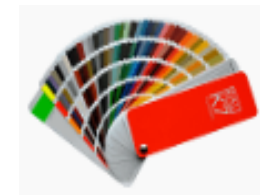

**FULL RAL COLOR
RANGE / EXTRA COST**

NOTE: All these colors except Green Ral 6005 and Desert Sand / Ivory are “super durables” which offer better durability compared with standard polyesters powders.

NOTE: ACTUAL FRAME COLOR MAY VARY FROM DIGITAL IMAGES





TEMPOTEST
ITALIAN PERFORMANCE FABRICS



ACRYLIC FABRIC COLLECTION



Fabric covers sewn with Tenara thread.



5 Forest Green



7 Moss Green



8 Medium Green



11 Red



12 Yellow



13 Ocean Blue



14 Toast

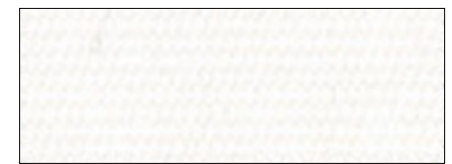

15 White



24 Black



33 Forest Green / White



35 Red / White



37 Yellow / White



47 Brown / Stone

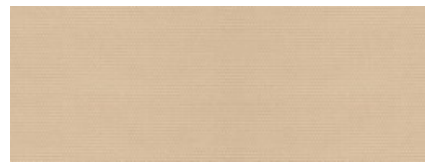

52 Tan



53 Pale Peach



73 Burgundy



75 Navy Blue



79 Grey



81 True Brown



84 Dark Terracotta

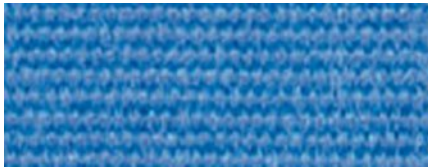

87 Fancy Blue



101 Elite Toast



102 Cappuccino



106 Toffee

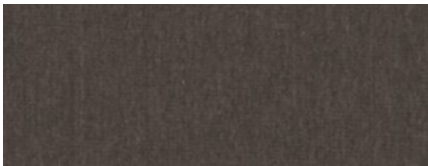

107 Textured Dk. Grey



242 Grey / White

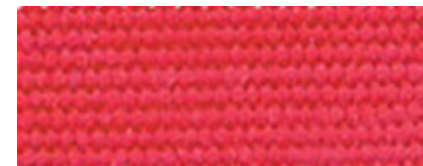

426 Terracotta



439 Dark Grey / White



809 Cream / Green



878 Beige / White Speckled



926 Taupe Classic Solid

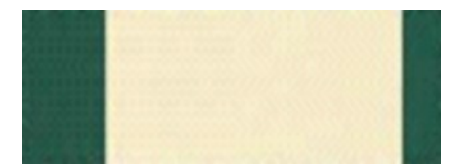

931 Green / Cream Wide



969 Grey Fancy Stripe

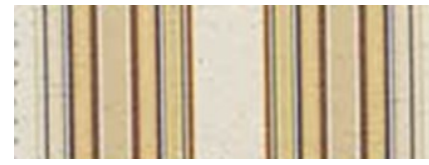

1101 Beige / Stripe Fancy



1120 Brown/ Beige Fancy



1150 Rust / Green Multi



116/15 Medium Blue / White



1243 Yellow Multi



1302 Sage Tweed



1330/512 Carbon Stitch



15/1 Beige



15/14 Raw



15/79 Stone



4015/91 Raw Speckled



407/11 Burgundy Tweed



407/13 Blue Tweed



407/14 Toast Classic Tweed



407/16 Moss Classic Tweed



407/3 Green Classic Tweed

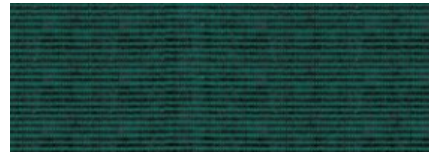

407/6 Green Tweed



407/79 Pepper Grey



407/926 Grey Classic Tweed



4215/15 Textured Tan



5000/57 Cocoa Stripe



5001/1 Green Graduated



5001/13 Blue Graduated



5001/7 Moss Graduated



5001/73 Burg/Grey Graduated



5009/1 Beige / Tan Stripe



5009/14 Brown / Tan Stripe



5011/11 Brick/Natural Fancy

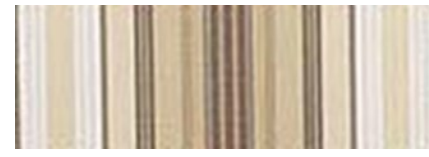

5011/57 Tan / Brown Fancy



5011/7 Tan / Green Fancy



5071/7 Natural/Moss Graduated



5072/86 Brown/Stone Fancy



5118/62 Yellow / White Fancy



5144/14 Pastel/Natural Fancy



5167/11 Red / Grey Fancy



5167/2 Blue / Grey Fancy

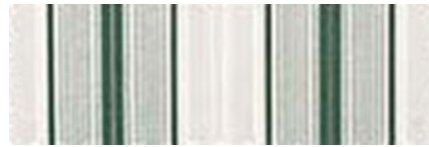

5167/5 Green / Grey Fancy



5173/12 Yellow / Grey Stripe



5304/15 Rose / Grey Fancy



5347/58 Grey Wheat Multi



5347/79 Platinum Grey Multi



5348/58 Beige / Wheat Multi



5348/79 Grey / Slate Multi



5349/106 Brown Cream Stripe

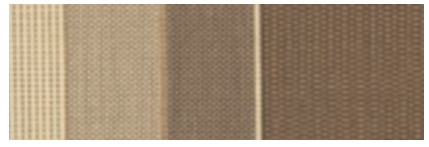

5349/930 Beige / Brown Classic

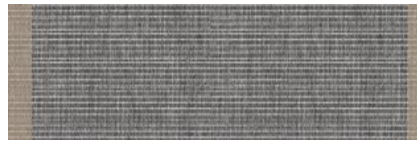

5369 Charcoal / Brown



5370 Beige / Grey



5371/727 Grey / Black Stripe

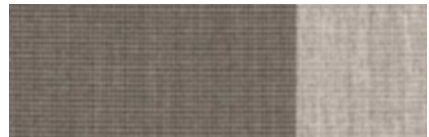

5374 Smoke / Grey Stripe



5396/78 Green Tweed Stripe

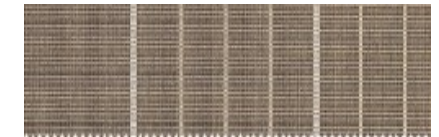

5396/930 Hazelnut Stripe



5396/97 Charcoal Tweed Stripe



5397/97 Grey / Black Graduated

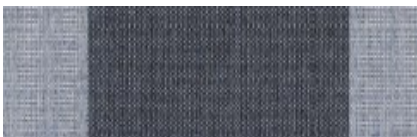

5398/107 Carbon Blue Blend

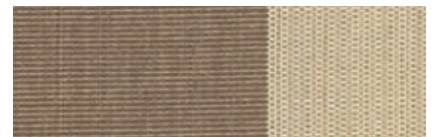

5398/930 Dune / Brown Striped

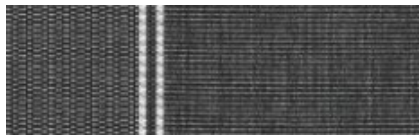

5399/107 Drk. Grey Tweed

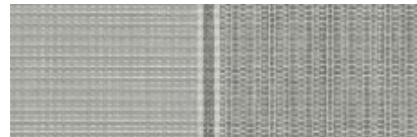

5399/15 Lgt. Grey Stripe

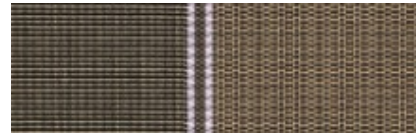

5399/52 Sesame Tweed
Stripe



5399/94 Stone / Grey
Tweed



5406/52 Coriander Tweed

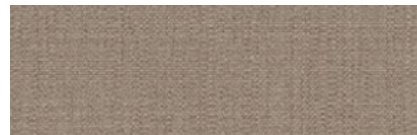

5406/94 Textured / Desert
Beige

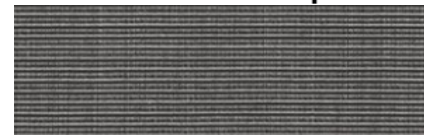

5407/107 Charcoal /
Stone Tweed



5407/15 Textured Silk
Grey

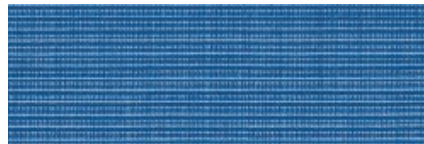

5407/17 Sky Tweed



5407/52 Sesame Tweed



5407/94 Desert Grey
Tweed



633/79 Grey/ Black Fancy



634/51 Grey / Natural Fancy



634/97 Green / Tan Fancy



635/11 Cranberry/Natural F.



636/10 Grey / Blue Graduated



636/12 Yellow Graduated



636/14 Brown Elite Stripe

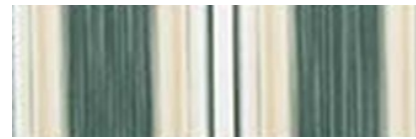

636/5 Green / Beige Fancy



636/84 Terracotta Graduated



638/5 Green Grey Fancy

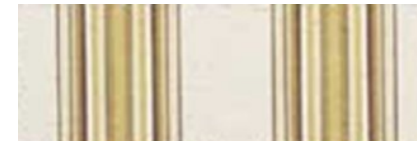

639/99 Tan / Natural Fancy



641/10 Blue / Beige Fancy

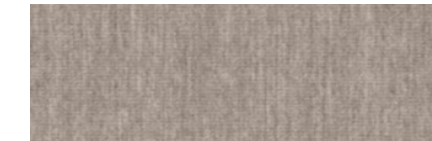

727/15 Textured Med. Grey



739/701 Sage / Beige Fancy



769/75 Cream / Blue Fancy



**782/14 Beige Classic
Solid**

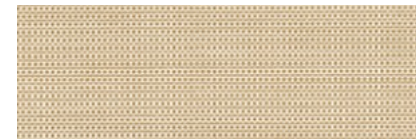

873/151 Dune Tweed

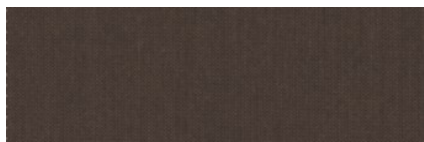

873/2 Textured Cocoa



939/94 Grey Elite Stripe



940/5 Green Elite Stripe



947/14 Pale / Beige Classic



**949/91 Brown Beige
Classic**

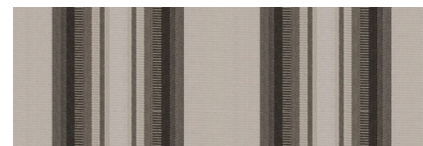

**950/24 Grey / Charcoal
Classic**

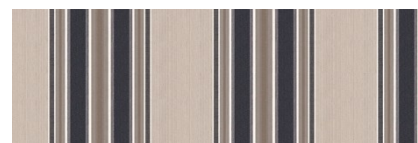

**951/92 Grey / Navy
Classic**



967/926 Grey/Charcoal Elite



**968/426 Terracotta Cream
Fancy**



97/84 Plum

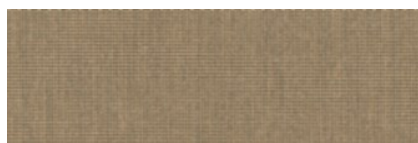

986/106 Textured Beige



986/15 Textured Lt. Grey



**986/727 Textured Pebble
Grey**

BINDING

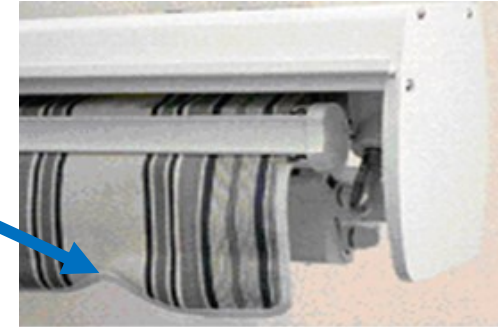

A Binding or Hem

E Standard

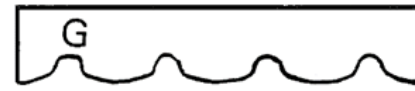

VALANCE STYLES

Note:

“A” style straight valance is available with either binding sewn in at bottom, or bottom hem, without binding. All remaining valance styles must have a binding sewn in at bottom (see binding color chart).

Standard valance styles are listed here. Some styles may vary depending on the pattern and where the stripes fall. If a custom valance is required, include a well-dimensioned sketch with the order as well as instructions on style. Our standard valance is “E”, if no valance style is specified, we use “E”.

BINDING COLORS

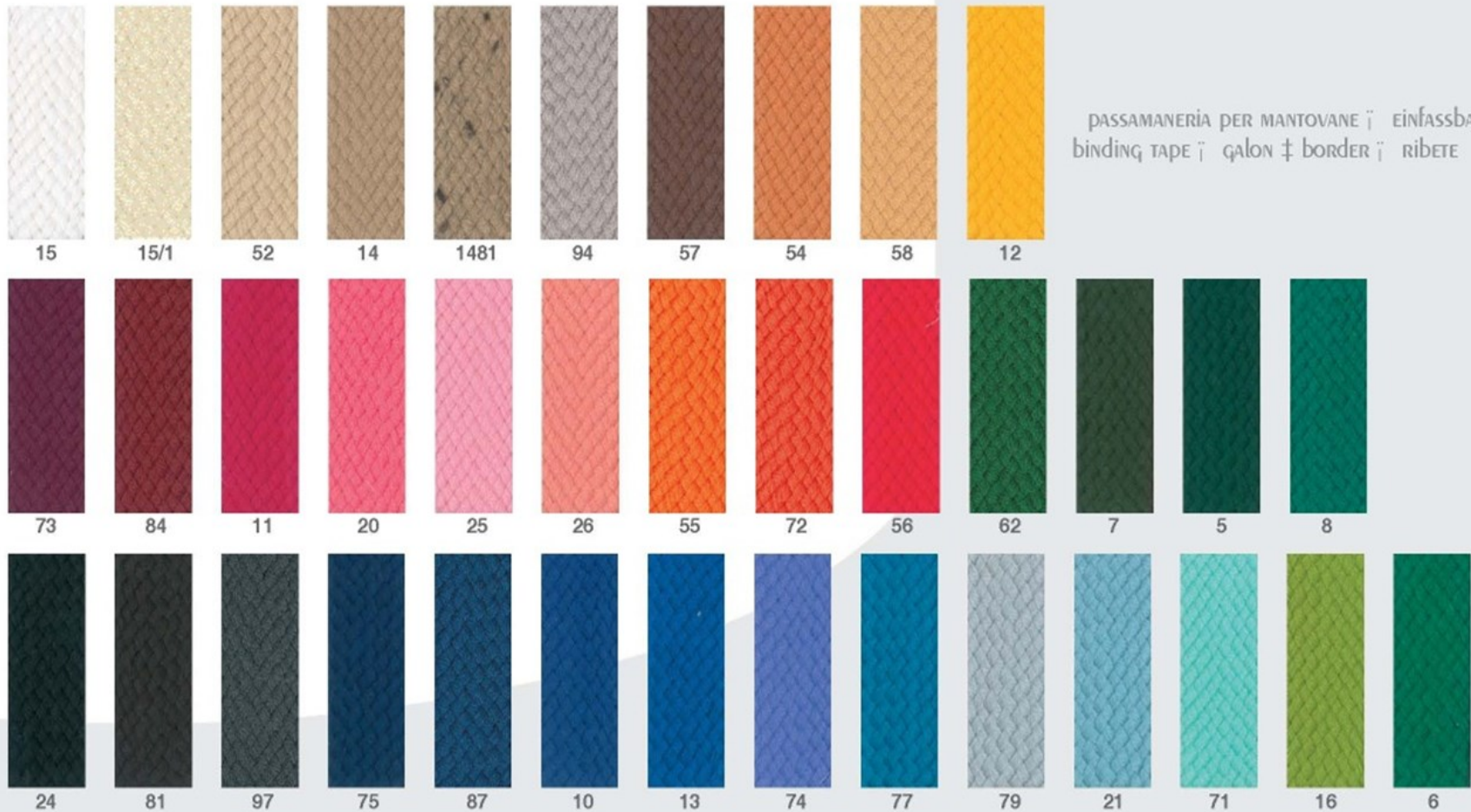

PASSAMANERIA PER MANTOVANE ; EINFASSBAND
 binding tape ; galon ≠ border ; ribete

Colori e numerazioni sono identici alle tinte unite del Tempotest ; Coloris et numération sont les mêmes que les unis du Tempotest

Colours and colour references correspond exactly to the Tempotest plains range ; Die Farben bzw. die Farbnummer stimmen mit den Tempotest Uni-Farben überein

Colores y numeración son iguales que los lisos del Tempotest



SOLIDS · TWEEDS · BLOCK STRIPES · FANCY STRIPES · GRADUATED STRIPES

5	Forest Green	407/14	Toast Classic Tweed	5406/52	Coriander Tweed
7	Moss Green	407/16	Moss Classic Tweed	5406/94	Textured Desert Beige
8	Medium Green	407/3	Green Classic Tweed	5407/107	Charcoal/Stone Tweed
11	Red	407/6	Green Tweed	5407/15	Textured Silk Grey
12	Yellow	407/79	Pepper Grey	5407/17	Sky Tweed
13	Ocean Blue	407/926	Grey Classic Tweed	5407/52	Sesame Tweed
14	Toast	4215/15	Textured Tan	5407/94	Desert Grey Tweed
15	White	5000/57	Cocoa Stripe	633/79	Grey/Black Fancy
24	Black	5001/1	Green Graduated	634/51	Grey/Natural Fancy
33	Forest Green/White	5001/13	Blue Graduated	634/97	Green/Tan Fancy
35	Red/White	5001/7	Moss Graduated	635/11	Cranberry/Natural Fancy
37	Yellow/White	5001/73	Burgundy/Grey Graduated	636/10	Grey/Blue Graduated
47	Brown/Stone	5009/1	Beige/Tan Stripe	636/12	Yellow Graduated
52	Tan	5009/14	Brown/Tan Stripe	636/14	Brown Elite Stripe
53	Pale Peach	5011/11	Brick/Natural Fancy	636/5	Green/Beige Fancy
73	Burgundy	5011/57	Tan/Brown Fancy	636/84	Terracotta Graduated
75	Navy Blue	5011/7	Tan/Green Fancy	638/5	Green/Grey Fancy
79	Grey	5071/7	Natural/Moss Graduated	639/99	Tan/Natural Fancy
81	True Brown	5072/86	Brown/Stone Fancy	641/10	Blue/Beige Fancy
84	Dark Terracotta	5118/62	Yellow/White Fancy	727/15	Textured Medium Grey
87	Fancy Blue	5144/14	Pastel/Natural Fancy	739/701	Sage/Beige Fancy
101	Elite Toast	5167/11	Red/Grey Fancy	769/75	Cream/Blue Fancy
102	Cappuccino	5167/2	Blue/Grey Fancy	782/14	Beige Solid Classic
106	Toffee	5167/5	Green/Grey Fancy	873/151	Dune Tweed
107	Textured Dark Grey	5173/12	Yellow/Grey Stripe	873/2	Textured Cocoa
242	Grey/White	5304/15	Rose/Grey Stripe	939/94	Grey Elite Stripe
426	Terracotta	5347/58	Grey/Wheat Multi	940/5	Green Elite Stripe
439	Dark Grey/White	5347/79	Platinum Grey Multi	947/14	Pale Beige Classic
809	Cream/Green	5348/58	Beige/Wheat Multi	949/91	Brown/Beige Classic
878	Beige/White Speckled	5348/79	Grey/Slate Multi	950/24	Grey/Charcoal Classic
926	Taupe Classic Solid	5349/106	Brown/Cream Stripe	951/92	Grey/Navy Classic
931	Green/Cream Wide	5349/930	Beige/Brown Classic	967/926	Grey/Charcoal Elite
969	Grey Fancy Stripe	5369	Charcoal/Brown	968/426	Terracotta/Cream Fancy
1101	Beige/Stripe Fancy	5370	Beige/Grey	97/84	Plum
1120	Brown/Beige Fancy	5371/727	Grey/Black Stripe	986/106	Textured Beige
1150	Rust/Green Multi	5374	Smoke/Grey Stripe	986/15	Textured Light Grey
116/15	Medium Blue/White	5396/78	Green Tweed Stripe	986/727	Textured Pebble Grey
1243	Yellow Multi	5396/930	Hazelnut Stripe		
1302	Sage Tweed	5396/97	Charcoal Tweed Stripe		
1330/512	Carbon Stitch	5397/97	Grey/Black Graduated		
15/1	Beige	5398/107	Carbon Blue Blend		
15/14	Raw	5398/930	Dune/Brown Stripe		
15/79	Stone	5399/107	Dark Grey Tweed		
4015/91	Raw Speckled	5399/15	Light Grey Stripe		
407/11	Burgundy Tweed	5399/52	Sesame Tweed Stripe		
407/13	Blue Tweed	5399/94	Stone/Grey Tweed		



MOTORIZATION



Awnings



Exterior Screens



Pergolas



Roller/Solar Shades

Sunair is proud to offer the full line of Somfy motors and controls for our awnings and screens program. SOMFY RTS features motors with an integrated radio receiver that allows you to operate the awning by remote control with a wall mounted or hand held remote or by smart phone device. With a simple click of your remote, the awning or shade will extend or retract automatically. The manual override Sunea motor is ideal for awnings and the Altus motors is ideal for exterior screens. Each motor can be configured with a cord & plug which can simply be plugged into your patio outlet. They are available in 1.4", 11', 17', & 23' lengths. Altus motor cords depend on motor model and is standard either 6' or 10' pigtail cords. Optional Altus plug in cords are available in 10', 18', and 24' lengths. Optional screen motor is Maestria with obstacle detection. Add Tahoma smart phone and table interface.



Sunea quick connect

Twist & Lock Fast Connector Solution for 500 Series Motors

Available 500 Series Motor cable options Q4 2019

SUNEA CORDS*

- Optional LT50 pigtails :
 - 1.6FT SJTW pigtail with LT50 plug on one end & FC on the other
 - 4 conductor version for Wired motors
 - 3 conductor version for RTS & SDN motors
- Optional extensions in various lengths for both 4 & 3 conductor cables.
 - same extensions for all AC motors - Sunea, Dia. 40 & 50 ranges
 - interior & exterior rated
 - simplify our offer and standardize going forward with the possibility to totally eliminate the Anderson connector

- Version 4 Conductors (for WT motors – mechanical LSUs)



- Version 3 Conductors (for RTS & SDN motors – electronics LSUs)

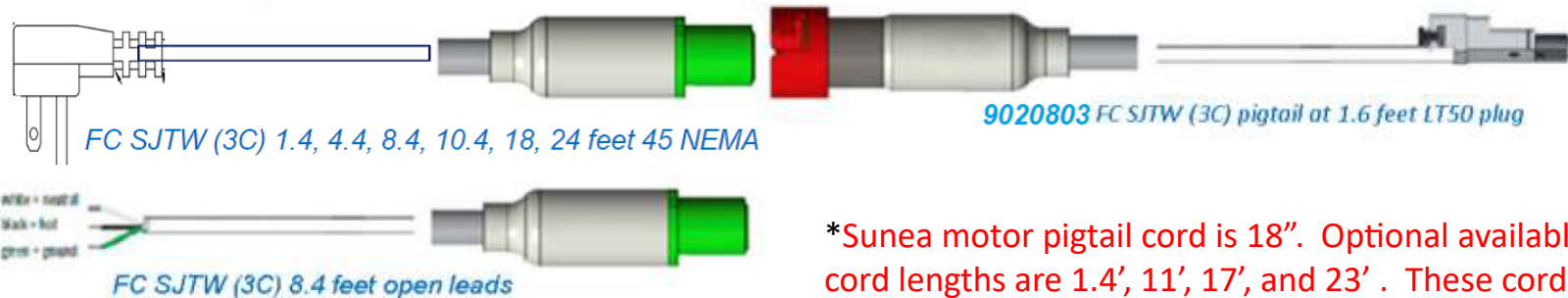

*Sunea motor pigtail cord is 18". Optional available plug cord lengths are 1.4', 11', 17', and 23'. These cords come with a molded plug that can be plugged into an outlet.

SOMFY REMOTES:



Telis 1 & 4 RTS
Hand-held Remotes



Situ 1 & 4 hand
held remotes

One (1) through (16) channel hand held or wall mounted remotes are available. Remotes are available in different colors to suit your style, please inquire.



Telis hand-held remotes offer convenient and simple operation of every type of motorized application. Channels help organize the motorized products that are operated. Single channel remotes can operate one individual product or one group of motorized products. Multiple channel remotes can handle groups of motorized products.



Telis 1 Chronis
RTS Timer



DecoFlex WireFree™ RTS
Wall Switches



Telis 1 Patio for
exterior use



Smooove® 1 RTS
Surface Mount Wall Switch



Telis 16 RTS
Hand-held Remote

AVAILABLE AUTOMATIC SENSORS & CONTROLS



EOLIS 3D WIREFREE™ RTS

**Wind sensor for lateral
Arm Awnings only**

The Eolis 3D WireFree™ RTS Wind Sensor is a wireless, battery powered wind sensor that will automatically retract an awning based on wind generated movements.



SOLIRIS RTS 24V KIT
Sun & Wind Sensor

The Soliris RTS Sun and Wind Sensor automatically controls your RTS motorized products based on current weather conditions.



ONDEIS® WIREFREE
Sun & Rain Sensor

The Rain Sensor is a solar-powered combined rain and sun sensor compatible with Radio Technology Somfy® motorized exterior products, including awnings and screens.



Sunis & ThermoSunis
Indoor WireFree™ RTS Sensors

Dimensions

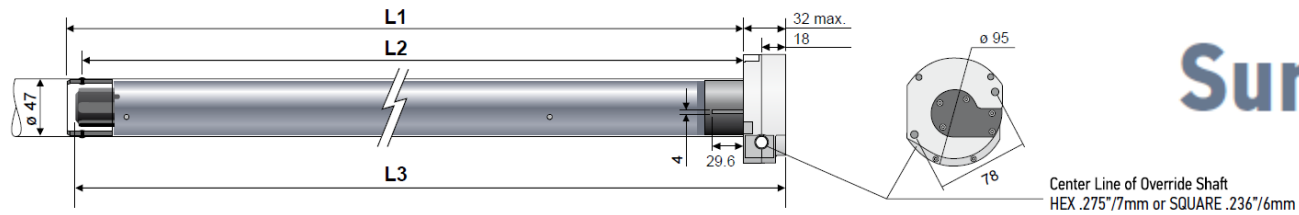

Sunea® RTS CMO



525A2 CMO

25 Nm
120V / 60HZ
1.6A
20 rpm

535A2 CMO

35 Nm
120V / 60HZ
2.1A
20 rpm

550R2 CMO

50 Nm
120V / 60HZ
2.1A
14 rpm

660

60 Nm (530 in. lbs.)
120V / 60Hz
2.5A
14 rpm



Somfy TaHoma® RTS Smartphone and Tablet Interface

The Somfy TaHoma® gateway and smart phone app provides convenient and customized control of Somfy powered motorized shades, blinds, and other motorized solutions. Control up to 40 RTS (Radio Technology Somfy) channels using the TaHoma app. Multiple TaHoma devices can be joined for multi-zone control.



- North America app, you can remotely activate both Zigbee and RTS products Supports UP/DOWN/MY/STOP commands for motorized shades/blinds .
- Supports incremental control for Tilt motors and lighting ☑ Supports ON/OFF commands for control of lighting or other devices powered via the Zigbee Smart Plug Multiple users .
- Remote access Control4® Certified ☑ Integration with third-party systems over IP ☑ Compatible with Somfy Synergy™ API



TaHoma® RTS



Bond Home / Smartphone and Tablet Interface

Bond Bridge and Bond Bridge Pro works as a bridge between Wi-Fi and your remotes recorded signal allowing you to operate your Sunair shades, awnings, pergolas, ceiling fans, fireplaces and more with the Bond app. Works with Somfy and other motor manufacturers.



Remote control from anywhere

Be able to control everything even from outside your home.



Bond Bridge

- Works with Alexa, Google Home, and SmartThings,
- Remote Control via Bond Home app
- Works with iPhone or Android
- No installation needed
- Smart home functionality without breaking the bank

Bond Bridge Pro: **Added features...**

- Ethernet port & PoE technology
- Smart home integrations
- Ceiling and wall mount

OPTIONAL:

- Sidekick for Shades: 5-channel Shade and awning

BOND REMOTE SWITCH:

Sidekick for Shades/Awnings: 5-channel Shade Keypad



- Wireless flush mount shade remote.
- Communicates directly with the shade.
- 10-year battery life.
- Set up shade limits – no manufacturer remote required.
- This version of Sidekick does not support Scene Keypad functionality.
- 10-year battery life.
- Install with or without a workbox (flush mount).
- 5-channel control.
- Set up shade limits – no manufacturer remote required.



Notes

**Note: Sunair® reserves the right to change engineering, specifications and prices without notice.
Images and Illustrations in the catalog may vary from digital and printed manuals.**

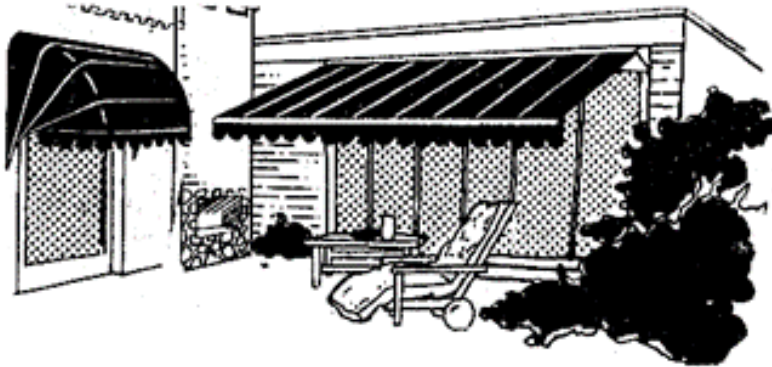

SUNPROOFING AMERICA!



MARYLAND LOCATION

Mailing: P.O. Box 1068
Shipping: 7785 Rt. 175
Jessup, MD 20794

Toll Free 800 - 548 - 0408
Phone: 410 - 799 - 1145
Fax: 410 - 799 - 5584

ARIZONA LOCATION

Mailing: Same as Jessup
Shipping: 3807 West Thomas Rd.
Phoenix, AZ 85017

Toll Free 877 - 272 - 3920
Phone: 602 - 272 - 3920
Fax: 602 - 272 - 3925

www.sunairawnings.com

info@sunairawnings.com